

ALÜMİNYUM PROFİLLERİN GENEL TEKNİK ŞARTNAMESİ TECHNICAL SPECIFICATIONS OF ALUMINIUM PROFILES

SIRA NO ROW NO	KATSAYILAR FEATURE	DEĞERİ VALUE	BİRİMİ UNIT
1.	Özgül Ağırlık <i>Specific Weight</i>	2.71	gr / cm ³
2.	Kullanılan Billet <i>Billet Details</i>	AlMgSi0.5	DIN - Almanya <i>DIN - GERMANY</i>
		6063	BS - İngiltere <i>BS - UK</i>
		60	ETIAL - Türkiye <i>ETIAL - TURKEY</i>
3.	Genleşme Katsayısı <i>Expansion Coefficient</i>	23.4	20 - 100 C°
4.	Elastisite Modülü <i>Elasticity Module</i>	6,89	GPa
5.	Çekme Mukavemeti <i>Tensile Strength</i>	215	(24 C de MPa)
6.	Uzama <i>Elongation</i>	% 6	Delta L / L * 100 (50 mm uzunlukta) (50 mm length)
7.	Sertlik <i>Hardness</i>	70	Brinell (HB)
8.	Akma Mukavemeti <i>Flow Strength</i>	170	MPa
9.	Kesme Mukavemeti <i>Cutting Strength</i>	130	MPa
10.	Boyanın Kalınlığı <i>Coating Thickness</i>	> 60	Micron
11.	Eloksal Kalınlığı <i>Anodizing Thickness</i>	> 10	Micron
	(Eloksal kalınlığı isteğe bağlı olarak 25 micron'a kadar çıkabilir. (Anodizing thickness can be up to 25 microns.)		

Boyalı profillerde, kesitlere göre birim ağırlık % 2 ~4 nispetinde artar.

Mekanik özellikler T6 temperi için verilmiştir.

"Weight per unit increases by 2-4 % after powder- coating."

"Specifications are given for T6 temper"

EN AW-6063 ALAŞIMIN KİMYASAL BİLEŞİMİ

AlMgSi0.5 ALLOY CHEMICAL COMPOSITION

Element	Si	Fe	Cu	Mn	Mg	Zn	Ti	Cr	Diğer Elementler <i>Other Elements</i>	
									Herbiri <i>Each one</i>	Toplam <i>Total</i>
Min.	0.20	-	-	-	0.45	-	-	-	-	-
Max.	0.60	0.35	0.10	0.10	0.90	0.10	0.10	0.10	0.05	0.15

ÜRETİLEBİLEN MAX. PROFİL BOYUTLARI MAXIMUM PRODUCTION DIMENSIONS

İÇİ BOŞ PROFİLLER İÇİN HOLLOW PROFILES

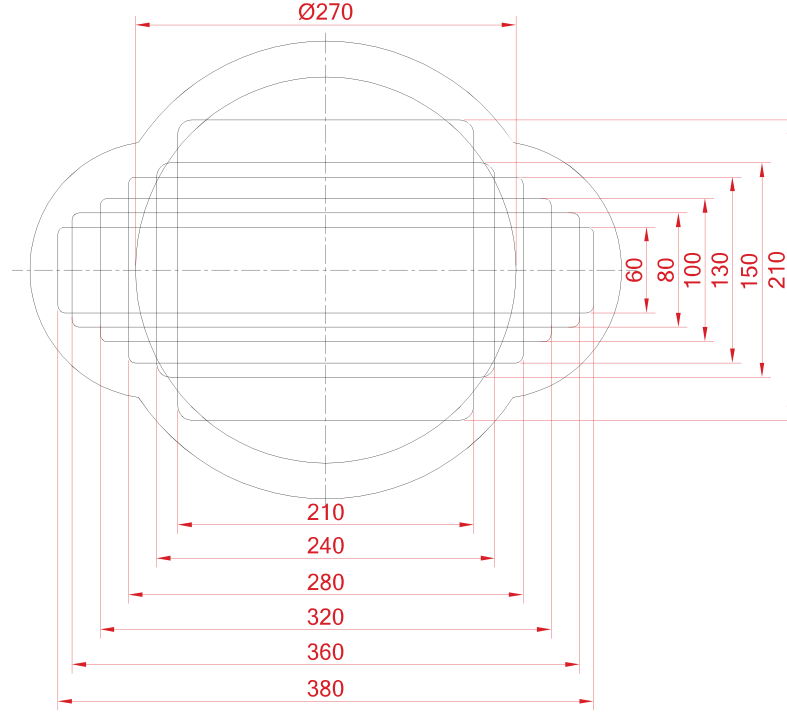

DOLU PROFİLLER İÇİN SOLID PROFILES

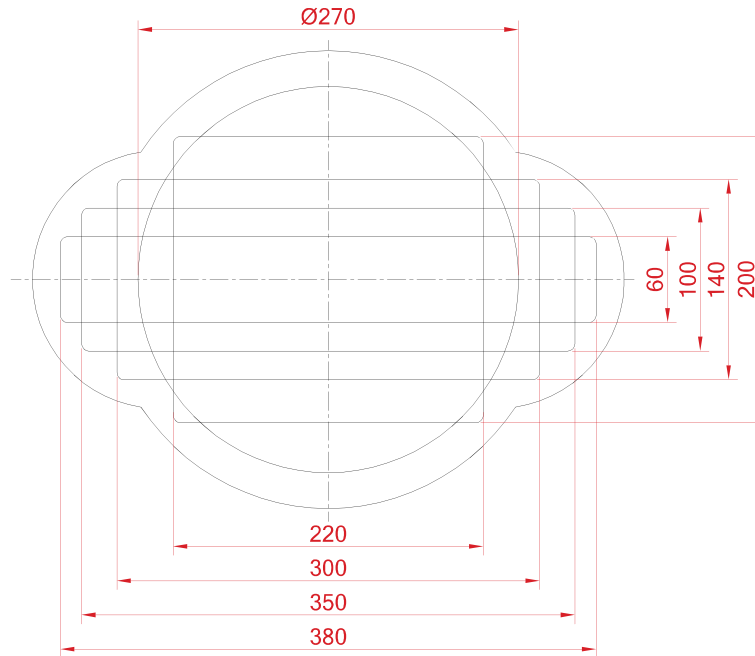



PROFİL VE SERİLER Profiles and Series	SAYFA NO	PROFİL VE SERİLER Profiles and Series	SAYFA NO
STANDART PROFİLLER Standard Profiles	01 - 08	WD55 SERİSİ WD55 Series	64 - 67
LAMBRİ ve GRİYAJ PRF. Panel and Grillage Profiles	09	WD55 THERMO SERİSİ WD55 Thermo Series	68 - 72
T BİNİ ve SİNEKLİK PROFİLLERİ T-Bin and Screening Profiles	10	WD60 SERİSİ WD60 Series	73 - 74
DUŞ KABİN PROFİLLERİ Shower Cabin Profiles	11	WD64 THERMO SERİSİ WD64 Thermo Series	75 - 79
JALUZI - BRANDA PROFİLLERİ Jalousie - Awning Profiles	12	HVT67 SERİSİ HVT67 Thermo Series	80
SEHPA ve DOLAP PROFİLLERİ Table and Cupboard Profiles	12	HVT77 SERİSİ HVT77 Thermo Series	81
AC 22 COTTA SERİSİ AC 22 Cotta Series	13	WD70 THERMO SERİSİ WD70 Thermo Series	82 - 84
AS50/AS55 SERAMİK VE TAŞ SİSTEM PRF. Ceramic Facade	13	WD86 THERMO SERİSİ WD86 Thermo Series	85 - 86
MOBİLYA PROFİLLERİ Furniture Profiles	14	SH110 GİYOTİN SERİSİ SH110 Guillotine Series	87
DENİZLİK PROFİLLERİ Window Sill Profiles	15	AD40 ECO AYARLI KAPI SERİSİ AD40 Eco Adjustable Door Series	88
MENFEZ PROFİLLERİ Vent Profiles	16	AD40-AD55 AYARLI KAPI SERİSİ AD40-AD55 Adjustable Door Series	89
SS 60 KAYAR PANJUR PROFİLLERİ SS60 Sliding Shutter Profiles	16	FD60 THERMO KATLANIR KAPI SERİSİ FD60 Thermo Bi-Fold Door Series	90 - 91
PANJUR PROFİLLERİ Shutter Profiles	17 - 20	FS50 CEPHE SERİSİ FS50 Facade Series	92 - 96
YUVARLAK KÜPEŞTE PRF. Handrail Profiles(Round)	21 - 27	FS 50 ECO CEPHE SERİSİ FS 50 ECO Facade Series	97 - 98
KARE KÜPEŞTE PROFİLLERİ Handrail Profiles(Rectangular,Round)	28 - 34	FS 50 ECO SIZE CEPHE SERİSİ FS 50 ECO Size Facade Series	98
LR70-LR100-LR152 KÜPEŞTE PROFİLLERİ LR70-LR100-LR125 Handrail Profiles(Rectangular,Round)	35	FS 65 ÇELİK TAKVİYELİ CEPHE FS 65 Steel Reinforced Facade Series	99
AKSESUAR PROFİLLERİ Accessory Profiles	36 - 38	FS 70 CEPHE SERİSİ FS 70 Facade Series	99
ÖZEL PROFİLLER Special Profiles	39 - 41	SKY 65 IŞIKLIK SERİSİ SKY 65 Skylight Series	100
ALDOKS SERİSİ Aldoks Series	42 - 44	SB GÜNEŞ KIRICI SERİSİ SB Sunshade Series	101
TS29 TUBA SÜRME SERİSİ(67 mm) TS29 Tuba Sliding Series	45	CP 50 KOMPOZİT PANEL PRF CP 50 Composite Panel Profiles	102
TS45 TUBA SÜRME SERİSİ (100 mm) TS45 Tuba Sliding Series	46	MF20-MS20-OP30 LOFT SERİSİ MF20-MS20-OP30 Loft Series	103
İZMİR SÜRME SERİSİ İzmir Sliding Series	47	STEELLOOK LOFT SERİSİ Steellook Loft Series	103
KIBRIS SÜRME SERİSİ Cyprus Sliding Series	47	OP 40 OFİS BÖLME PROFİLLERİ OP 40 Office Partition Profiles	104
S28 SÜRME SERİSİ S28 Sliding Series	48	OP 100 OFİS BÖLME PROFİLLERİ OP 100 Office Partition Profiles	105
S 32 SÜRME SERİSİ S 32 Sliding Series	49	SÜPÜRGELİK VE EŞİK PRF. Baseboard and Threshold Profiles	106
CS34 SÜRME SERİSİ CS34 Sliding Series	50	CB 40 CAM BALKON SERİSİ CB 40 Balcony Glazing Profiles	107
CS35 THERMO SÜRME SERİSİ CS35 Thermo Sliding Series	50	ICB 40 ISICAMLI CAM BALKON SERİSİ ICB 40 Heat Insulated Folding Balcony Glass Series	107
S35 NOVOLINE SÜRME SERİSİ S35 Novoline Sliding Series	51	SCB 100 SÜRME CAM BALKON SERİSİ SCB 100 Sliding Balcony Glazing Series	108
S35 THERMO NOVOLINE SÜRME SERİSİ S35 Thermo Novoline Sliding Series	52 - 53	ISCB 140 SÜRME ISICAMLI BALKON SERİSİ ISCB 140 Sliding Heat Insulated Balcony Glazing Series	109
S38 THERMO SÜRME SERİSİ S38 Thermo Sliding Series	54 - 55	WG 70T THERMO KIŞ BAHÇESİ SERİSİ WG 70T Winter Garden Thermo Series	110-111
HS55 THERMO SÜRME SERİSİ HS55 Thermo Lift and Slide Series	56 - 57		
WD37 SERİSİ WD37 Series	58 - 59		
WD45 SERİSİ WD45 Series	60 - 61		
WD50 THERMO SERİSİ WD50 Thermo Series	62 - 63		



STANDART PROFİLLER STANDARD PROFILES

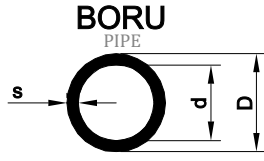

Profil No	D mm	d mm	s mm	Kg/m
1047	8	5	1.5	0.083
5620	9.2	6.5	1.35	0.090
1573	10	5	2.5	0.160
6368	12	10	1.0	0.094
3098	12.5	9.1	1.7	0.156
2618	13	10.6	1.2	0.121
7356	13.9	11.1	1.4	0.149
4090	14	12	1.0	0.111
3112	14.6	10	2.3	0.241
10372	15.8	13.4	1.2	0.149
2878	15.8	13	1.4	0.172
1234	15.8	12	1.9	0.224
492	15.8	9.8	3.0	0.327
562	15.8	9	3.4	0.359
3148	15.8	8	3.9	0.395
471	15.8	7	4.4	0.427
916	15.8	6	4.9	0.454
4133	15.8	5	5.4	0.478
6511	16	13	1.5	0.185
925	16	12	2.0	0.240
5737	17	15	1.0	0.136
6224	18	15	1.5	0.211
4349	18.15	14.15	2.0	0.275
1229	18.3	16.3	1.0	0.147
919	19	16.6	1.2	0.181
976	19	14	2.5	0.353
2687	19.4	16.4	1.5	0.229
914	19.8	12.2	3.8	0.517
2563	20	18	1.0	0.163
3922	20	17.6	1.2	0.192
4901	20	16	2.0	0.307
905	20	15	2.5	0.372
1572	20	14	3.0	0.434
977	20	12	4.0	0.545
2610	20	7	6.5	0.747
915	20	5	7.5	0.795
11177	20.8	10.4	5.2	0.691
5736	21.5	19.5	1.0	0.175
4278	22	19	1.5	0.261
4775	22	18	2.0	0.341
926	22	16.4	2.8	0.458
8039	24	21	1.5	0.287
979	24	18	3.0	0.537
698	24	16.5	3.75	0.647
699	24	14	5.0	0.810
2662	24	7	8.5	1.122
2974	24	5	9.5	1.173
918	25	22.4	1.3	0.262
3729	25	22	1.5	0.300
901	25	18.5	3.25	0.602
6887	25	10.5	7.25	1.096
10669	25	20	2.5	0.479
11176	25	21	2.0	0.392
10664	25.8	22.8	1.5	0.310

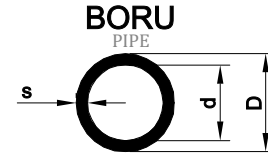

Profil No	D mm	d mm	s mm	Kg/m
10665	25.8	20.8	2.5	0.496
16884	26.5	22.5	2.0	0.417
7266	27	8	9.5	1.415
7260	27	10	8.5	1.339
9892	27	24.6	1.2	0.264
927	27.5	22.4	2.55	0.542
4746	28	25	1.5	0.338
1582	29.5	25	2.25	0.550
3327	30	27	1.5	0.364
1571	30	26	2.0	0.477
908	30	24	3.0	0.690
978	30	22	4.0	0.886
2477	30	20	5.0	1.065
2177	30	16.5	6.75	1.336
924	30	14.1	7.95	1.492
931	30	10	10.0	1.703
7402	33	25	4.0	0.988
13081	33	30.4	1.3	0.351
10646	34.5	20.9	6.8	1.604
11882	35	16	9.5	2.065
5609	35	33	1.0	0.290
5726	35	32	1.5	0.428
3326	35	31	2.0	0.562
476	35	30.3	2.35	0.653
4778	35	30	2.5	0.692
4124	35	29.6	2.7	0.743
1575	35	29	3.0	0.817
904	35	28.5	3.25	0.879
995	35	8.5	13.25	2.452
1017	35	6.5	14.25	2.517
5667	36	30	3.0	0.843
2906	40	37.4	1.3	0.428
3826	40	36	2.0	0.647
910	40	35	2.5	0.798
8053	40	34	3.0	0.945
7403	40	32	4.0	1.226
1012	40	30.5	4.75	1.425
11065	40	30	5.0	1.490
3753	40.2	6.5	16.85	3.350
3839	40.2	13	13.6	3.080
1015	40.2	10	15.1	3.227
6255	44	37.5	3.25	1.128
1420	44.3	40.6	1.85	0.669
616	44.8	14.5	15.15	3.824
5666	45	37	4.0	1.396
4052	45	35	5.0	1.702
5326	45	9	18.0	4.137
10567	45	41	2.0	0.732
7400	48	38	5.0	1.830
755	50	47.4	1.3	0.541
2622	50	47	1.5	0.620
2984	50	46.4	1.8	0.738
896	50	46	2.0	0.817
3066	50	45.6	2.2	0.895



STANDART PROFİLLER STANDARD PROFILES

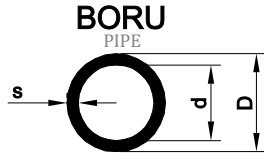

Profil No	D mm	d mm	s mm	Kg/m
917	50	45	2.5	1.011
932	50	44.1	2.95	1.182
4719	50	41	4.5	1.743
8109	50	40.5	4.75	1.830
2068	50	10	20.0	5.108
3812	50	7	21.5	5.217
2938	51.5	41	5.25	2.067
2845	53	40.5	6.25	2.488
3820	53.5	50.5	1.5	0.664
2846	54.5	50.5	2.0	0.894
2799	55	40.5	7.25	2.947
1016	55.3	50.3	2.5	1.124
1276	56.5	52.5	2.0	0.928
4528	56.6	54	1.3	0.612
2663	60	58	1.0	0.503
593	60	56	2.0	0.987
909	60	55	2.5	1.223
563	60	54	3.0	1.455
3924	60	50	5.0	2.341
1014	60	20.5	19.75	6.767
5937	63.5	57.5	3.0	1.545
1295	63.5	60.5	1.5	0.792
968	65	60.3	2.35	1.254
4054	67	22.5	22.3	8.476
920	68	56	6.0	3.120
12397	69	66	1.5	0.862
4051	70	40.5	14.8	6.938
786	70	67	1.5	0.875
913	72	40.2	15.9	7.596
4955	75	50.4	12.3	6.566
2064	75	45	15	7.662
3144	76	72	2.0	1.260
1290	76.1	73.1	1.5	0.954
7401	76.1	66.1	5.0	3.025
5938	76.2	70.2	3.0	1.869
3813	80	76	2.0	1.328
2664	80	78	1.0	0.673
912	82	50.2	15.9	8.948
4053	85	75	5.0	3.405
6907	85	76	4.5	3.084
4283	86	78	4.0	2.792
2538	90	86	2.0	1.498
10563	90	80	5.0	3.618
1038	92	28	32	16.346
2599	95	36	29.5	16.451
6403	99	93	3.0	2.452
5790	100	95	2.5	2.075
10564	100	90	5.0	4.044
6402	106	100	3.0	2.631
10252	110	102	4.0	3.609
10358	114	102	6.0	5.517
10826	120	110	5.0	4.895
4725	123	51	36	26.665
2053	125	50	37.5	27.936

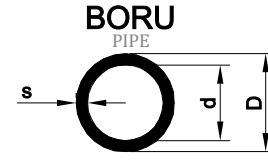

Profil No	D mm	d mm	s mm	Kg/m
6401	125	111	7.0	7.032
6173	125	109	8.0	7.969
1274	127	45	41	30.019
3345	127	123	2.0	2.128
7889	128	122.8	2.6	2.776
930	130	47	41.5	31.267
6171	135	121	7.0	7.628
5305	135	81	27	24.826
949	135	55	40	32.352
934	150	145	2.5	3.139
921	151.5	48.25	51.625	43.900
933	155	145	5.0	6.388
10359	160	144	8.0	10.352
2596	180	174	3.0	4.520
10976	180	170	5.0	7.450
11291	200	190	3.0	5.032
10234	200	190	5.0	8.300
11203	215	207	4.0	7.186
11202	260	252	4.0	8.718



STANDART PROFİLLER

STANDARD PROFILES

KARE KUTU

SQUARE TUBE

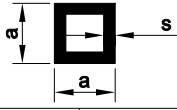

Profil No	a mm	s mm	Kg/m
1576	10	1.8	0.160
12620	14	1.2	0.166
9698	14	1.5	0.201
1409	14	2.0	0.258
5861	16	1.2	0.192
5637	17.4	1.2	0.200
4971	20	1.0	0.206
3752	20	1.2	0.245
10886	20	1.5	0.301
7399	20	2.0	0.390
212	25	1.5	0.382
274	25	2.0	0.499
4316	26	1.6	0.418
213	30	1.5	0.463
8340	30	2.0	0.607
214	35	1.5	0.545
7346	39.5	0.9	0.377
6450	39.6	1.0	0.418
116	40	1.1	0.464
215	40	1.5	0.626
6041	40	2.0	0.824
4174	40	2.3	0.950
3925	40	3.0	1.202
5771	45	1.4	0.662
3067	45	2.0	0.932
4336	45.5	5.0	2.193
4123	48.4	3.9	1.879
12958	50	1.5	0.788
3124	50	1.8	0.940
627	50	2.0	1.040
3923	50	3.0	1.528
4103	53.8	6.6	3.374
2611	60	1.5	0.951
11771	60	2.0	1.257
3927	60	3.0	1.853
8804	70	4.0	2.861
7273	70	4.5	3.195
9702	75	1.8	1.428
2612	80	2.0	1.691
6580	90	2.0	1.908
10475	90	3.0	2.829
629	94	2.0	1.994
2613	100	2.0	2.124
10846	100	3.0	3.154
5433	100	4.0	4.163
10579	100	5.0	5.147
4692	110	2.0	2.341
5492	110	3.0	3.431
11772	120	3.0	3.805
11773	140	3.0	4.455
9743	150	2.5	3.997
9906	150	3.0	4.780
10476	150	4.0	6.330
10562	150	5.0	7.856
11883	152.4	9.5	14.707

KARE KUTU

SQUARE TUBE

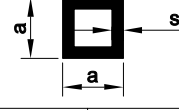

Profil No	a mm	s mm	Kg/m
11774	160	3.0	5.105
12599	200	3.0	6.827

T - PROFİLLER

T-PROFILES

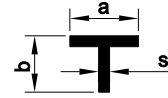

Profil No	a mm	b mm	s mm	Kg/m
156	25	25	1.1	0.146
511	30	15	1.2	0.142
133	30	30	1.2	0.191
187	30	30	1.5	0.237
810	30	90	6.0	1.853
2969	40	40	1.5	0.324
8276	40	40	3.0	0.626
10565	50	50	5.0	1.285
8275	60	50	3.0	0.870
10977	80	50	2.0	0.693
11051	80	60	4.0	1.474



STANDART PROFİLLER STANDARD PROFILES

DİKDÖRTGEN KUTU RECTANGLE TUBE

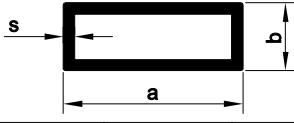

Profil No	a mm	b mm	s mm	Kg/m
3892	12.4	10	1.0	0.108
3716	15	12.5	1.2	0.162
4923	18.2	10.9	1.2	0.174
1261	25	15	1.2	0.244
167	25	17	1.1	0.237
10982	29.5	22	2.0	0.514
2824	30	11	1.5	0.307
8801	30	15	1.5	0.341
9644	35	25	1.5	0.464
4106	37.4	30.4	2.5	0.851
298	40	20	1.0	0.314
230	40	20	1.2	0.374
8805	40	20	1.3	0.404
489	40	20	1.7	0.521
3905	40	20	1.8	0.550
5669	40	20	2.0	0.605
226	40	30	1.1	0.404
10981	41.5	22	2.0	0.644
8269	43	30	1.8	0.677
11564	44.3	28	1.0	0.380
12067	44.6	25.6	2.0	0.715
13128	50	10	1.5	0.463
3043	50	20	1.8	0.648
10580	50	25	2.0	0.767
7512	50	30	1.5	0.626
4227	50	30	2.0	0.823
2384	50	30	3.0	1.201
129	50	40	1.1	0.524
7877	50	40	1.6	0.753
4948	55	35	1.5	0.707
2471	60	13	1.8	0.676
411	60	20	1.2	0.504
5406	60	25	2.0	0.869
11887	60	30	2.0	0.932
1236	60	40	1.3	0.686
2987	60	40	1.8	0.940
11121	60	40	2.0	1.040
239	67	21	1.3	0.601
4060	70	30	0.9	0.478
12225	70	30	2.0	1.040
10179	72	40	2.0	1.170
11767	75	25	1.8	0.940
128	75	32	1.1	0.625
168	75	32	1.4	0.790
11981	80	15	1.0	0.504
406	80	20	1.2	0.635
10474	80	20	3.0	1.528
12517	80	50	1.4	0.965
1413	80	40	1.3	0.827
7878	80	40	1.6	1.013
232	80	40	2.0	1.257
3928	80	40	3.0	1.853
4550	90	40	3.0	2.015
722	90	50	1.7	1.259

DİKDÖRTGEN KUTU RECTANGLE TUBE

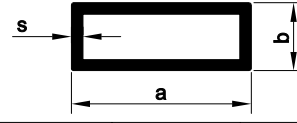

Profil No	a mm	b mm	s mm	Kg/m
628	94	50	2.0	1.516
8943	95	50	1.5	1.155
7479	100	20	1.0	0.639
2204	100	20	1.2	0.765
7879	100	20	1.6	1.013
3816	100	20	2.0	1.257
11768	100	25	1.8	1.184
9746	100	40	1.8	1.331
1237	100	50	1.8	1.428
516	100	50	3.0	2.341
8802	100	50	4.0	3.078
12426	105	20	1.2	0.797
7361	110	44	2.0	1.625
5951	120	60	1.5	1.439
419	120	60	2.0	1.908
8803	120	60	4.0	3.729
11378	130	80	2.0	2.232
10150	150	30	1.6	1.533
9747	150	50	1.7	1.811
197	150	50	2.0	2.124
7698	150	50	3.0	3.154
4899	150	50	5.0	5.149
4900	150	50	6.0	6.113
7633	150	80	3.0	3.640
10539	150	100	2.0	2.666
8025	160	20	1.8	1.721
1145	170	40	2.0	2.232
12425	180	120	3.0	4.780
2274	200	35	2.2	2.750
12094	200	40	2.5	3.184
11188	200	60	4.0	5.463
6632	200	80	3.0	4.455
8058	200	100	2.2	3.524
7735	200	100	3.0	4.780
11130	220	120	3.5	6.316
8171	280	60	3.0	5.431
12611	300	60	3.0	5.756



STANDART PROFİLLER STANDARD PROFILES

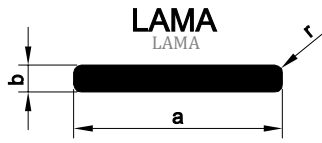

Profil No	a mm	b mm	r mm	Kg/m
240	10	3	0.5	0.080
4855	12	7	1.2	0.224
1648	13.4	1.4	0.3	0.051
353	15	2.5	0.3	0.102
1603	15	3	0.5	0.122
2536	16	4	0.5	0.173
10884	19	9.0	0.3	0.463
10017	20	2	0.3	0.108
2572	20	3	0.3	0.163
4321	20	3	1.5	0.157
11547	20	4	1.0	0.215
6299	20	5	2.5	0.256
11064	20	5	1.0	0.269
6367	20	6	0.5	0.325
10018	25	2	0.3	0.135
12951	25	3	0.3	0.203
2733	25	4	0.5	0.271
2657	25	6	0.5	0.406
11355	25	10	0.3	0.677
11171	25	20	1.5	1.350
3060	26	6.3	3.15	0.423
4516	30	2	0.3	0.162
3896	30	3	0.3	0.243
2736	30	6	0.5	0.487
5792	30	6.5	0.5	0.528
5738	30	25	1.0	2.030
1211	32	22	1.5	1.903
1672	34	1.4	0.3	0.129
3938	37.6	5	0.5	0.509
4020	38	4.8	0.5	0.494
409	40	1.2	0.3	0.130
10583	40	3.0	1.0	0.323
10582	40	5.0	1.0	0.540
2737	40	5.5	0.5	0.596
5793	40	6.5	0.5	0.704
1609	40	6.8	0.3	0.737
334	40	8	1.0	0.865
245	40	10	1.0	1.081
4288	40	15	0.3	1.626
3904	40	20	0.5	2.167
1247	42	20	0.5	2.276
12528	45	11	1.0	1.705
343	45	24	2.0	2.917
2690	46	20	1.0	2.491
7712	49.6	3	0.3	0.403
4517	50	2	0.3	0.271
2180	50	5	0.5	0.677
4834	50	7	0.7	0.949
5871	50	10	1.0	1.353
2805	50	18	2.0	2.430
8460	50	25	1.0	3.385
2617	50	30	1.0	4.063
12791	50	40	0.5	5.419
4632	55	3	0.3	0.447

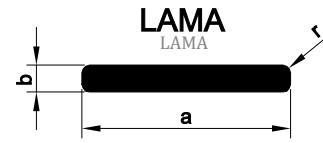

Profil No	a mm	b mm	r mm	Kg/m
4627	55	6	3.0	0.873
11140	55	12	0.5	1.788
6791	60	1.2	0.3	0.195
4906	60	4	0.3	0.650
10560	60	5	1.0	0.811
5872	60	10	1.0	1.624
10561	60	15	1.0	2.437
10885	60	20	1.0	3.249
10434	60	45	1.0	7.314
7101	60.2	25.2	5.1	4.051
8493	60.4	25.4	4.0	4.121
11139	65	15	0.5	2.642
559	70	6	0.3	1.138
10820	70	15	0.5	2.845
249	70	10	1.0	1.894
4341	70	32	5.0	6.012
4631	75	3	1.5	0.604
4626	75	6	3.0	1.199
10367	75	15	0.5	3.048
169	79.5	6.7	3.35	1.417
8492	80.4	30.4	4.0	6.589
6714	80	2.4	0.3	0.520
561	84.5	4	0.3	0.916
568	86.7	4.1	0.3	0.963
2821	100	1.5	0.3	0.406
407	100	3.5	1.75	0.941
344	100	5	1.0	1.353
277	100	7	3.5	1.870
252	100	8	4.0	2.081
251	100	8	1.0	2.165
250	100	10	1.0	2.707
253	100	10	5.0	2.652
6976	100	20	1.0	5.418
4630	110	3	0.3	0.895
4625	110	6	3.0	1.768
8322	120	3	0.3	0.975
2474	120	5	0.5	1.625
4629	130	3	0.3	1.057
358	130	5	2.5	1.747
361	130	6	3.0	2.093
364	130	8	4.0	2.781
2822	150	1.5	0.3	0.609
4289	150	10	0.3	4.065
1205	150	15	1.0	6.095
6172	150	30	1.0	12.195
5549	160	10	0.3	4.336
8792	160	15	0.3	6.504
4628	180	3	0.3	1.464
4623	180	6	3.0	2.906
4638	180	7.5	3.75	3.626
3044	180	10	1.0	4.876
2823	200	1.8	0.3	0.975
8793	200	10	0.5	5.419
206	200	15	2.0	8.122



STANDART PROFİLLER STANDARD PROFILES

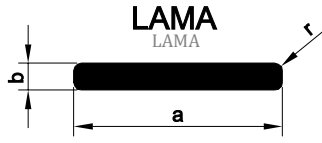

Profil No	a mm	b mm	r mm	Kg/m
8794	200	18	0.5	9.755
2179	200	20	2.0	10.830
205	200	25	2.0	13.542
812	220	4	0.5	2.385
2634	250	20	2.0	13.541
5128	250	22	2.0	14.896
3810	250	25	2.0	16.928
4049	275	27	2.0	20.114

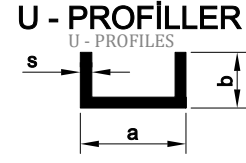

Profil No	a mm	b mm	s mm	Kg/m
8961	9.2	22	1.1	0.152
10040	12	18	1.5	0.183
10019	12	12	1.0	0.092
2849	12.7	10.5	1.0	0.085
3167	13	27.7	1.2	0.214
6192	14	12	2.95	0.256
4104	14	20	3.0	0.391
4200	15	15	2.0	0.222
6540	15	17	1.25	0.157
140	15	30	3.0	0.560
408	16	20	2.0	0.282
12422	16	30	2.0	0.390
142	17	17	1.1	0.145
3132	17.6	11	1.6	0.155
220	18	20	1.1	0.166
938	19	8	2.0	0.168
4201	20	20	2.0	0.303
4202	20	30	2.0	0.411
4203	20	40	2.0	0.520
540	21	21	1.1	0.181
1564	21.9	25	1.2	0.225
11909	23	20	1.3	0.212
3984	25	12	1.65	0.204
8381	26	5	2.0	0.173
2535	26	22	3.0	0.520
845	27	25	1.2	0.249
7568	27.5	25	1.2	0.244
2459	32.8	40	3.0	0.868
10378	35	35	2.0	0.547
12515	36	30	1.8	0.450
8125	40	40	2.0	0.629
221	40.6	40.6	3.0	0.941
12516	41	30	1.8	0.475
634	42	35	1.3	0.385
1258	43.2	40	1.2	0.392
2334	43.5	20.5	1.2	0.267
8420	45	43	2.0	0.688
3859	45.4	21	1.3	0.298
2496	53	10	1.5	0.284
11855	55.5	29	2.0	0.592
8474	65	25	1.5	0.455
8270	85	72	3.0	1.813
2830	100	75	7.0	4.590
11675	104	80	5.0	3.440
10566	125	63	6.0	3.882
2831	150	75	7.0	5.538
382	161	30	2.0	1.176



STANDART PROFİLLER

STANDARD PROFILES

KÖŞEBENT

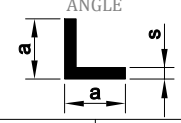

Profil No	a mm	s mm	Kg/m
189	15	1.3	0.101
208	15	1.5	0.117
5723	20	1.0	0.105
4645	20	1.1	0.116
163	20	1.2	0.126
209	20	2.0	0.206
10020	25	1.0	0.132
162	25	1.2	0.158
210	25	2.0	0.260
4287	25	3.0	0.382
5722	30	1.1	0.175
8806	30	2.0	0.314
8800	30	3.0	0.463
161	30	1.2	0.191
2141	40	1.2	0.256
10015	40	1.5	0.318
2458	40	2.0	0.422
1533	40	2.7	0.566
3926	40	3.0	0.625
164	40	4.0	0.824
3756	50	1.5	0.400
5635	50	2.0	0.531
8341	50	3.0	0.788
270	50	5.0	1.287
2200	60	1.5	0.482
2475	60	2.0	0.639
7705	75	5.0	1.964
4286	75	8.0	3.078
2201	80	1.5	0.644
4958	80	8.0	3.294
2544	90	15	6.696

KARE

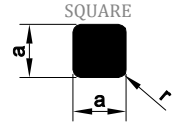

Profil No	a mm	r mm	Kg/m
3101	4.8	0.3	0.062
5791	7.5	0.3	0.153
2735	8.2	0.3	0.182
3146	10	0.6	0.270
4101	14	1.0	0.529
1030	15	0.5	0.609
10581	16	1.0	0.691
1021	20	0.5	1.084
204	30	1.0	2.440
279	35	1.0	3.320
4102	40	1.0	4.334
10368	50	1.0	6.772
7261	71	1.0	13.659
12792	80	1.0	17.342

YUVARLAK

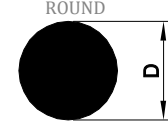

Profil No	D mm	Kg/m
2708	6	0.077
2677	8	0.136
4320	9.8	0.204
2678	10	0.212
5613	14	0.417
1027	16	0.545
3065	18	0.689
911	19.9	0.842
10469	21	0.938
1593	22	1.030
966	24	1.228
1271	25	1.331
2877	26	1.439
1028	30	1.916
1020	35	2.607
1019	40	3.405
1263	40.5	3.491
3064	45	4.310
1018	50.2	5.364
703	55.5	6.556
1023	60	7.662
2623	66	9.271
556	68	9.842
1040	70	10.430
5896	80	13.621
2948	85	15.378
907	100	21.285



LAMBRİ PROFİLLERİ PANEL PROFILES

114 0.326 kg/m 	222 0.378 kg/m 	229 0.358 kg/m 	115 0.610 kg/m
174 0.879 kg/m 	4624 0.508 kg/m 	5955 0.622 kg/m 	5956 1.254 kg/m
5688 0.511 kg/m 	785 1.017 kg/m 		



GRİYAJ PROFİLLERİ GRILLAGE PROFILES

122 0.205 kg/m 	123 0.110 kg/m 	126 0.553 kg/m 	127 0.296 kg/m



T BİNİ (PERVAZ) PROFİLLERİ T-BIN (SILL) PROFILES

1121 0.232 kg/m 	3832 0.175 kg/m 	1139 0.239 kg/m 	1035 0.239 kg/m
3818 0.210 kg/m 	5788 0.205 kg/m 	6414 0.175 kg/m 	3917 0.162 kg/m
7039 0.260 kg/m 	553 0.656 kg/m 	10012 0.805 kg/m 	



SİNEKLİK PROFİLLERİ SCREENING PROFILES

542 0.442 kg/m 	543 0.232 kg/m 	545 0.184 kg/m 	544 0.177 kg/m
547 0.139 kg/m 	548 0.261 kg/m 	549 0.186 kg/m 	4087 0.218 kg/m
4933 0.337 kg/m 	2276 0.609 kg/m 	2277 0.145 kg/m 	2278 0.362 kg/m
2239 0.284 kg/m 	5719 0.232 kg/m 	5720 0.246 kg/m 	1243 0.434 kg/m
11968 0.411 kg/m 	11969 0.438 kg/m 	12339 0.703 kg/m 	



DUŞ KABİN PROFİLLERİ



SHOWER CABIN PROFILES

<p>3167 0.214 kg/m</p>	<p>3156 0.252 kg/m</p>	<p>3157 0.276 kg/m</p>	<p>3158 0.256 kg/m</p>
<p>3161 0.513 kg/m</p>	<p>3159 0.482 kg/m</p>	<p>3151 0.384 kg/m</p>	<p>3165 0.261 kg/m</p>
<p>3160 0.252 kg/m</p>	<p>3164 0.239 kg/m</p>	<p>3166 0.342 kg/m</p>	<p>3162 0.334 kg/m</p>
<p>3163 0.445 kg/m</p>	<p>3171 0.285 kg/m</p>	<p>3150 0.546 kg/m</p>	<p>3048 0.350 kg/m</p>
<p>3170 0.339 kg/m</p>	<p>3178 0.274 kg/m</p>	<p>3173 0.926 kg/m</p>	<p>3051 0.443 kg/m</p>
<p>3049 0.342 kg/m</p>	<p>3748 0.402 kg/m</p>	<p>3050 0.429 kg/m</p>	<p>3052 0.487 kg/m</p>

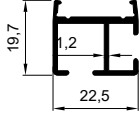
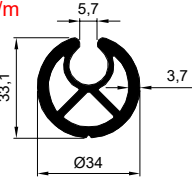

JALUZİ ve BRANDA PROFİLLERİ

JALOUSIE-AWNING PROFILES

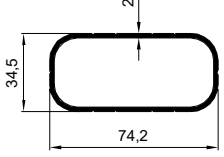
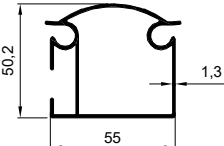
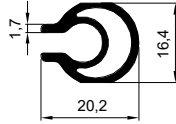
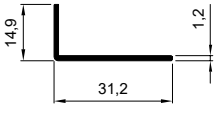
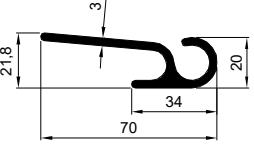
118 0.057 kg/m 	3100 0.277 kg/m 	2182 1.215 kg/m 	3101 0.062 kg/m 
3108 1.020 kg/m 	3109 0.937 kg/m 	3111 0.274 kg/m 	3092 0.145 kg/m 
2181 0.991 kg/m 			



SEHPA ve DOLAP PROFİLLERİ

TABLE AND CUPBOARD PROFILES

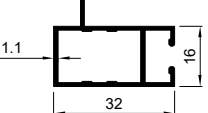
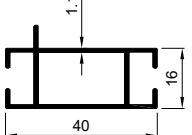
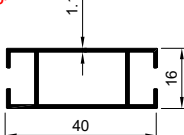
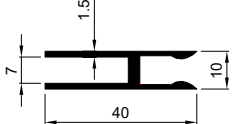
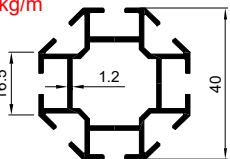
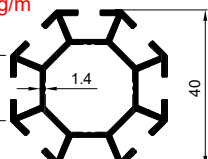
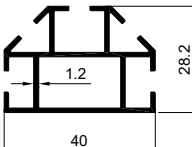
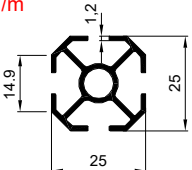
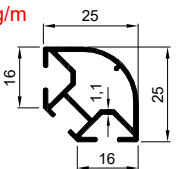
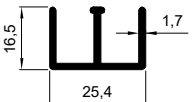
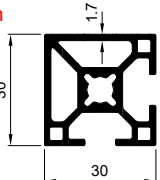
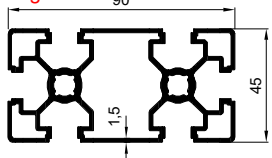
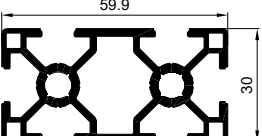
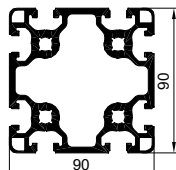
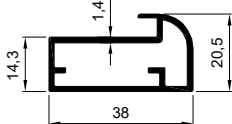
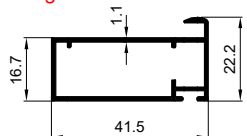
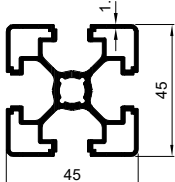
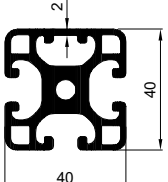
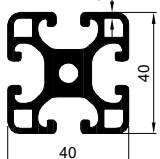
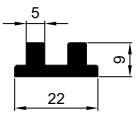
121 0.334 kg/m 	139 0.388 kg/m 	315 0.370 kg/m 	155 0.372 kg/m 
311 0.733 kg/m 	472 0.838 kg/m 	312 0.577 kg/m 	313 0.399 kg/m 
192 0.352 kg/m 	177 0.311 kg/m 	1269 0.864 kg/m 	6128 2.359 kg/m 
7075 1.366 kg/m 	7076 6.087 kg/m 	1401 0.464 kg/m 	5907 0.398 kg/m 
5371 1.278 kg/m 	1051 1.827 kg/m 	1050 1.781 kg/m 	176 0.341 kg/m 



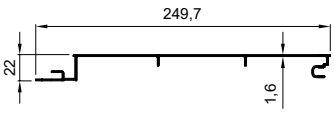
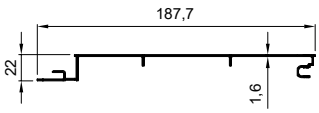
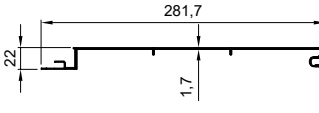
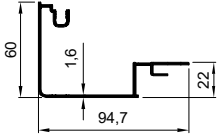
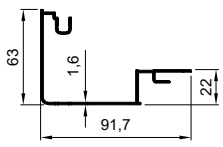
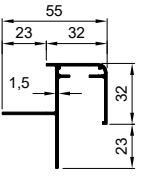
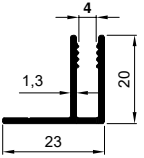

AC22 COTTA SERİSİ AC22 COTTA SERIES

8500 1.482 kg/m 	8600 1.214 kg/m 	10388 1.840 kg/m 	8501 0.984 kg/m 
8502 0.984 kg/m 	8503 0.651 kg/m 	477 0.220 kg/m 	

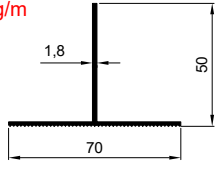
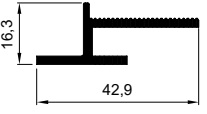
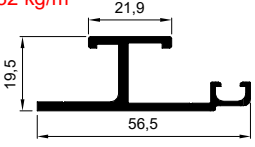
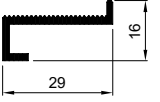

AS50/AS55 SERAMİK VE TAŞ SİSTEM PROFİLLERİ AS50/AS55 CERAMIC FACADE PROFILES

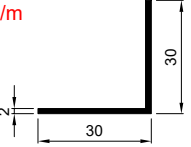
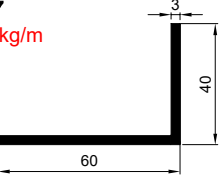
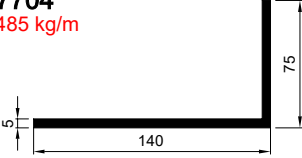
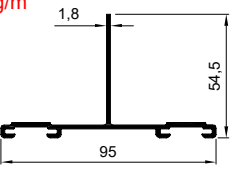
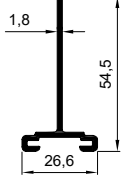
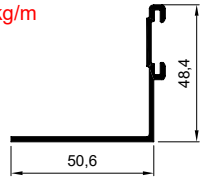
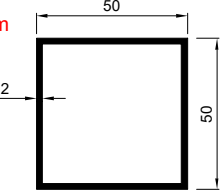
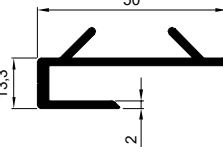
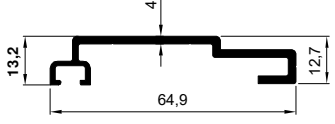
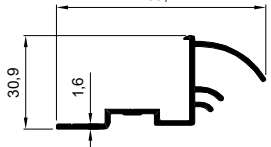
9790 0.529 kg/m 	11870 0.378 kg/m 	11872 0.582 kg/m 	11869 0.254 kg/m 
11868 0.238 kg/m 	8806 0.314 kg/m 	557 0.788 kg/m 	7704 2.485 kg/m 
11876 0.867 kg/m 	11874 0.445 kg/m 	11875 0.557 kg/m 	627 1.040 kg/m 
11871 0.574 kg/m 	11873 0.514 kg/m 	10389 0.691 kg/m 	



MOBİLYA PROFİLLERİ

FURNITURE PROFILES

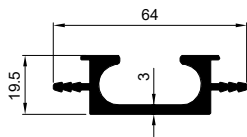
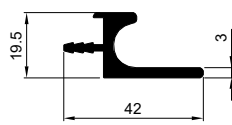
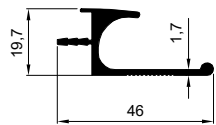
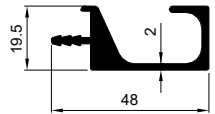
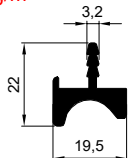
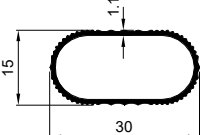
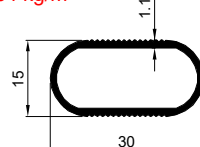
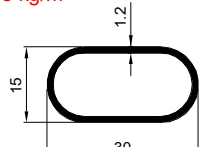
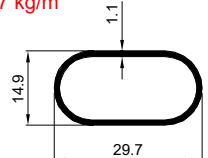
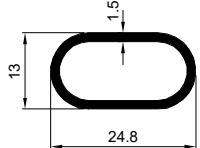
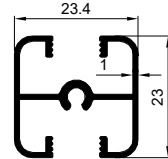
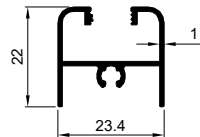
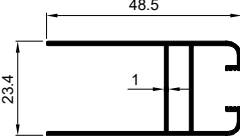
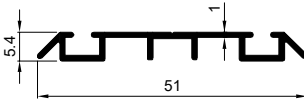
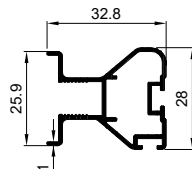
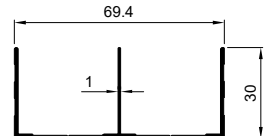
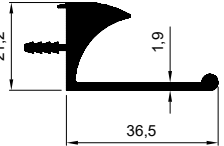
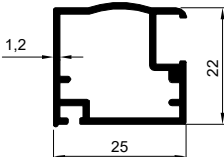
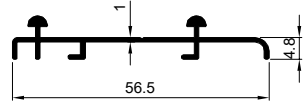
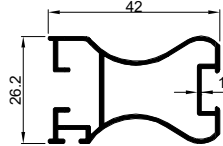
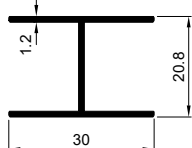
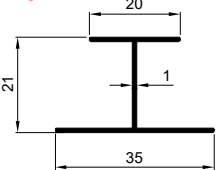
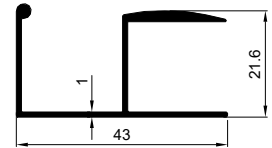
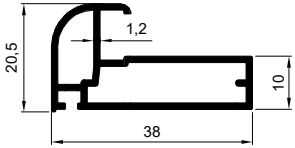
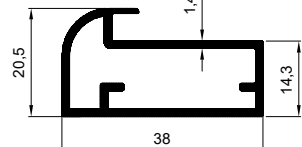
<p>329 0.992 kg/m</p> 	<p>330 0.576 kg/m</p> 	<p>3118 0.450 kg/m</p> 	<p>333 0.751 kg/m</p> 
<p>331 0.395 kg/m</p> 	<p>3356 0.185 kg/m</p> 	<p>1679 0.264 kg/m</p> 	<p>2202 0.238 kg/m</p> 
<p>5629 0.217 kg/m</p> 	<p>6348 0.243 kg/m</p> 	<p>523 0.311 kg/m</p> 	<p>524 0.268 kg/m</p> 
<p>525 0.440 kg/m</p> 	<p>526 0.237 kg/m</p> 	<p>527 0.409 kg/m</p> 	<p>528 0.462 kg/m</p> 
<p>1400 0.606 kg/m</p> 	<p>1364 0.357 kg/m</p> 	<p>529 0.274 kg/m</p> 	<p>4932 0.455 kg/m</p> 
<p>515 0.254 kg/m</p> 	<p>5653 0.200 kg/m</p> 	<p>3030 0.343 kg/m</p> 	<p>1363 0.421 kg/m</p> 
<p>1401 0.464 kg/m</p> 			



DENİZLİK PROFİLLERİ

WINDOW SILL PROFILES

10670 0.363 kg/m 	10671 0.407 kg/m 	10672 0.468 kg/m 	10673 0.591 kg/m
10674 0.640 kg/m 	10675 0.745 kg/m 	10676 0.858 kg/m 	10677 0.915 kg/m
10678 0.972 kg/m 	10679 1.029 kg/m 	10680 1.164 kg/m 	10681 1.408 kg/m
10682 1.587 kg/m 	10683 1.868 kg/m 	10684 2.593 kg/m 	
570 0.428 kg/m 	571 0.458 kg/m 	572 0.580 kg/m 	573 0.629 kg/m
574 0.733 kg/m 	575 0.845 kg/m 	582 0.964 kg/m 	576 1.026 kg/m
577 1.157 kg/m 	578 1.297 kg/m 	579 1.390 kg/m 	580 1.568 kg/m
581 1.846 kg/m 			



MENFEZ PROFİLLERİ VENT PROFILES

5479 0.189 kg/m 	4070 0.273 kg/m 	4904 0.264 kg/m 	3078 0.527 kg/m
1034 0.542 kg/m 	175 0.345 kg/m 	3848 0.353 kg/m 	550 0.224 kg/m
2239 0.284 kg/m 	2851 0.411 kg/m 	5685 0.270 kg/m 	5683 0.132 kg/m
551 0.267 kg/m 	552 0.146 kg/m 	4905 0.293 kg/m 	3836 0.142 kg/m
5684 0.270 kg/m 			



SS60 KAYAR PANJUR PROFİLLERİ SS60 SLIDING SHUTTER PROFILES

8921 1.982 kg/m 	8922 0.859 kg/m 	8923 0.861 kg/m 	8924 1.002 kg/m
8925 0.847 kg/m 	8926 0.529 kg/m 	8927 0.484 kg/m 	8928 0.385 kg/m



PANJUR PROFİLLERİ

SHUTTER PROFILES

583 0.522 kg/m 	3465 0.623 kg/m 	3454 0.685 kg/m 	3430 0.615 kg/m
3421 0.669 kg/m 	3467 0.455 kg/m 	4253 0.490 kg/m 	3471 0.423 kg/m
3472 0.466 kg/m 	3428 0.438 kg/m 	3460 0.500 kg/m 	3374 0.315 kg/m
6061 0.514 kg/m 	7581 0.393 kg/m 	6039 0.938 kg/m 	3455 0.736 kg/m
3466 0.583 kg/m 	3434 0.726 kg/m 	3485 0.555 kg/m 	3461 0.458 kg/m
3431 0.759 kg/m 	3469 0.579 kg/m 	3468 0.400 kg/m 	3371 1.280 kg/m
3483 1.133 kg/m 	3444 1.019 kg/m 	3409 0.931 kg/m 	3425 0.720 kg/m
5392 0.367 kg/m 	3426 0.462 kg/m 	3406 0.456 kg/m 	3361 0.415 kg/m



PANJUR PROFİLLERİ

SHUTTER PROFILES

3407 0.387 kg/m 	3427 0.334 kg/m 	2330 0.242 kg/m 	3440 0.600 kg/m
3358 0.439 kg/m 	3441 0.379 kg/m 	3458 0.350 kg/m 	3359 0.376 kg/m
218 0.336 kg/m 	1255 0.327 kg/m 	1254 0.451 kg/m 	3404 0.411 kg/m
3386 0.267 kg/m 	3446 0.710 kg/m 	3477 0.237 kg/m 	3357 0.240 kg/m
3432 0.330 kg/m 	3364 0.234 kg/m 	219 0.277 kg/m 	3437 0.328 kg/m
2211 0.320 kg/m 	3414 0.319 kg/m 	5997 0.399 kg/m 	3433 0.481 kg/m
3484 0.409 kg/m 	4080 0.323 kg/m 	3418 0.747 kg/m 	6330 0.446 kg/m
4276 0.698 kg/m 	3385 0.455 kg/m 	3424 0.483 kg/m 	3456 0.453 kg/m



PANJUR PROFİLLERİ

SHUTTER PROFILES

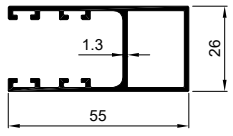
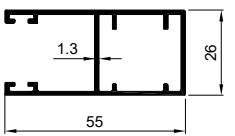
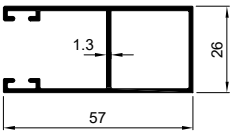
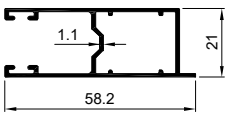
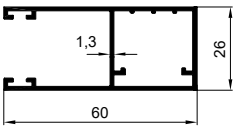
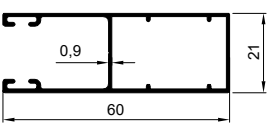
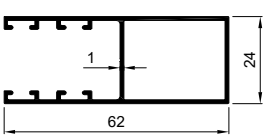
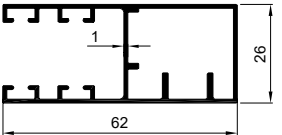
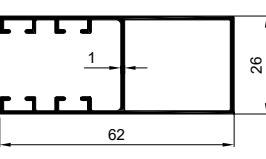
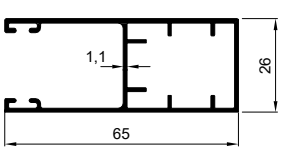
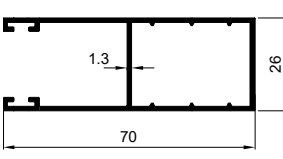
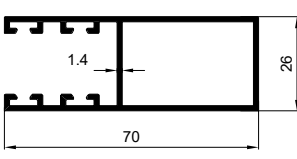
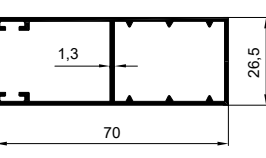
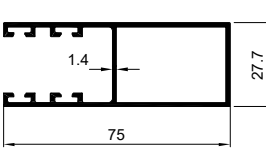
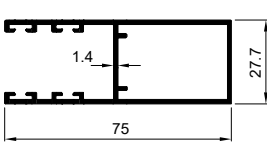
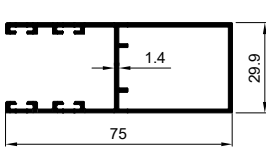
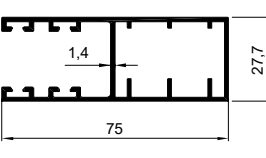
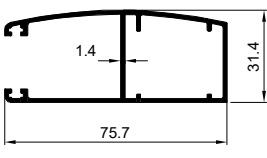
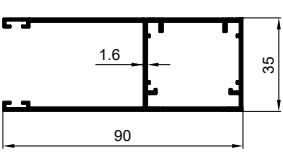
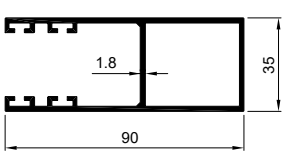
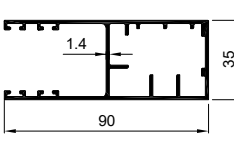
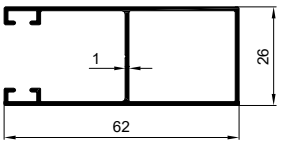
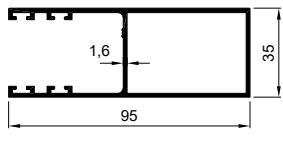
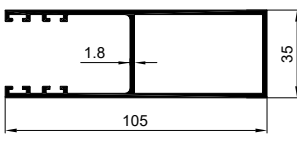
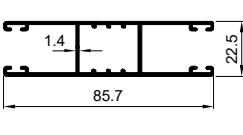
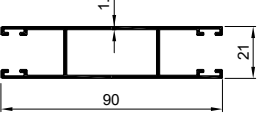
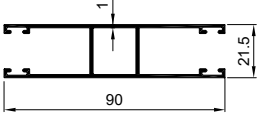
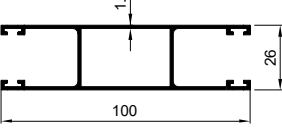
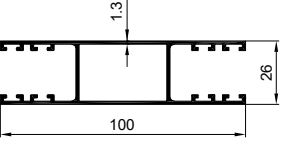
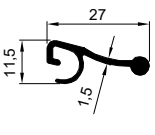
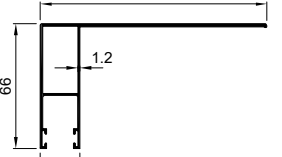
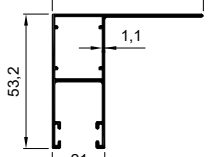
3435 0.680 kg/m 	3457 0.662 kg/m 	3423 0.634 kg/m 	3415 0.514 kg/m 
3390 0.683 kg/m 	3490 0.450 kg/m 	12239 0.542 kg/m 	3486 0.654 kg/m 
6407 0.584 kg/m 	3491 0.654 kg/m 	3391 0.730 kg/m 	3403 0.863 kg/m 
1253 0.754 kg/m 	3422 0.914 kg/m 	3474 0.901 kg/m 	3476 0.917 kg/m 
3417 1.002 kg/m 	4277 0.889 kg/m 	3392 1.169 kg/m 	3429 1.318 kg/m 
3362 1.227 kg/m 	8779 0.525 kg/m 	3487 1.243 kg/m 	3459 1.464 kg/m 
3473 0.947 kg/m 	3419 0.842 kg/m 	3420 0.845 kg/m 	5996 0.995 kg/m 
3453 1.111 kg/m 	3442 0.209 kg/m 	3416 1.000 kg/m 	3445 0.634 kg/m 



PANJUR PROFİLLERİ

SHUTTER PROFILES

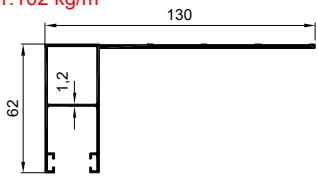
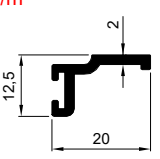
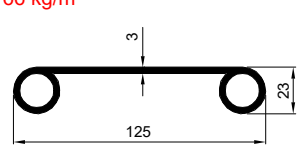
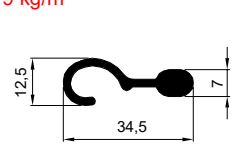
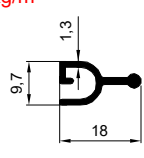
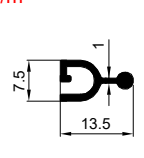
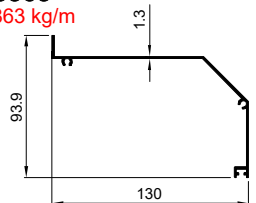
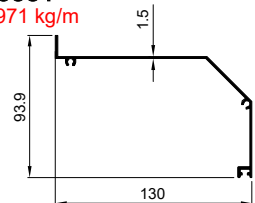
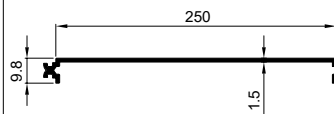
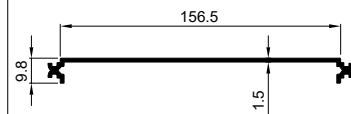
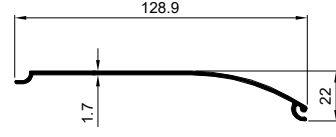
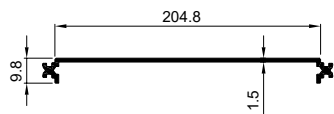
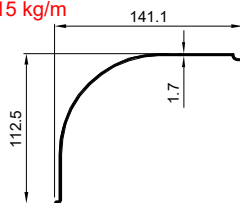
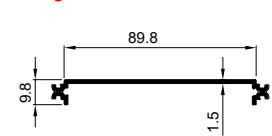
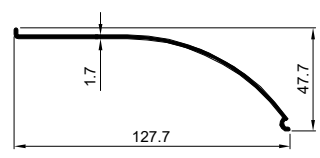
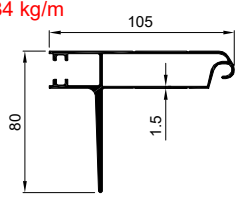
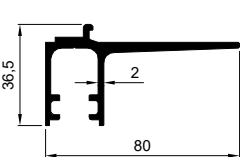
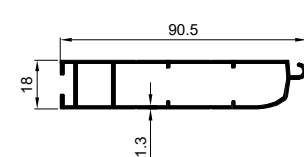
<p>11931 1.102 kg/m</p> 	<p>3413 0.182 kg/m</p> 	<p>3368 1.766 kg/m</p> 	<p>3408 0.379 kg/m</p> 
<p>3447 0.141 kg/m</p> 	<p>3443 0.098 kg/m</p> 	<p>3363 0.863 kg/m</p> 	<p>3381 0.971 kg/m</p> 
<p>3372 1.169 kg/m</p> 	<p>3382 0.791 kg/m</p> 	<p>3464 0.672 kg/m</p> 	<p>3370 0.986 kg/m</p> 
<p>3462 1.015 kg/m</p> 	<p>3369 0.518 kg/m</p> 	<p>3463 0.688 kg/m</p> 	<p>3405 1.584 kg/m</p> 
<p>3410 1.090 kg/m</p> 	<p>12530 0.831 kg/m</p> 		



YUVARLAK KÜPEŞTE PROFİLLERİ HANDRAIL PROFILE (ROUND)

1186 0.692 kg/m Kapak Profili : 1249 Cover Profile : 1249	1006 0.855 kg/m Kapak Profili : 1022 Cover Profile : 1022	1599 0.762 kg/m Kapak Profili : 1022 Cover Profile : 1022	1010 1.143 kg/m Kapak Profili : 1022 Cover Profile : 1022
2841 1.001 kg/m Kapak Profili : 2843 Cover Profile : 2843	973 1.529 kg/m Kapak Profili : 974 Cover Profile : 974	3089 0.877 kg/m Kapak Profili : 2843 Cover Profile : 2843	1680 0.880 kg/m Kapak Profili : 1022 Cover Profile : 1022
5727 0.833 kg/m Kapak Profili : 1022 Cover Profile : 1022	1565 0.911 kg/m Kapak Profili : 1022 Cover Profile : 1022	8271 0.682 kg/m Kapak Profili : 1022 Cover Profile : 1022	2842 0.822 kg/m Kapak Profili : 2843 Cover Profile : 2843
3090 0.714 kg/m Kapak Profili : 2843 Cover Profile : 2843	2879 0.755 kg/m Kapak Profili : 1022 Cover Profile : 1022	3024 0.788 kg/m Kapak Profili : 1022 Cover Profile : 1022	2993 1.017 kg/m Kapak Profili : 1022-2999 Cover Profile : 1022-2999
2246 0.855 kg/m Kapak Profili : 1022 Cover Profile : 1022	9932 0.807 kg/m Kapak Profili : 1022 Cover Profile : 1022	2245 0.673 kg/m Kapak Profili : 1022 Cover Profile : 1022	1592 0.679 kg/m Kapak Profili : 1022 Cover Profile : 1022
1099 0.956 kg/m Kapak Profili : 1022 Cover Profile : 1022	4085 0.769 kg/m Kapak Profili : 1022 Cover Profile : 1022	567 1.169 kg/m Kapak Profili : 1022 Cover Profile : 1022	1588 1.451 kg/m Kapak Profili : 1022 Cover Profile : 1022
566 1.537 kg/m Kapak Profili : 1022 Cover Profile : 1022	1022 0.073 kg/m Kapak Profili : 1022 Cover Profile : 1022	824 0.130 kg/m Kapak Profili : 1022 Cover Profile : 1022	974 0.113 kg/m Kapak Profili : 1022 Cover Profile : 1022
1249 0.073 kg/m Kapak Profili : 1022 Cover Profile : 1022	2843 0.075 kg/m Kapak Profili : 1022 Cover Profile : 1022	2826 0.072 kg/m Kapak Profili : 1022 Cover Profile : 1022	1574 0.081 kg/m Kapak Profili : 1022 Cover Profile : 1022



YUVARLAK KÜPEŞTE PROFİLLERİ



HANDRAIL PROFILE (ROUND)

2999 0.068 kg/m 	535 1.590 kg/m 	539 1.737 kg/m 	1260 1.806 kg/m
536 1.157 kg/m 	1596 1.401 kg/m 	1534 0.767 kg/m 	1595 1.087 kg/m
4706 0.814 kg/m 	1009 0.926 kg/m 	1029 0.840 kg/m 	1227 1.065 kg/m
1228 0.700 kg/m 	1984 0.774 kg/m 	1535 0.463 kg/m 	1540 0.872 kg/m
2882 1.038 kg/m 	2840 0.687 kg/m 	2839 1.143 kg/m 	1985 1.141 kg/m
1987 1.099 kg/m 	1986 0.729 kg/m 	5734 1.050 kg/m 	5735 0.644 kg/m
1259 1.417 kg/m 	4700 1.237 kg/m 	822 1.862 kg/m 	4891 1.054 kg/m
923 2.471 kg/m 	490 3.283 kg/m 	4892 1.196 kg/m 	5365 0.764 kg/m

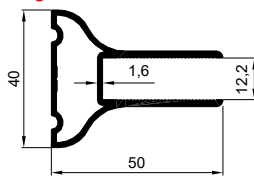
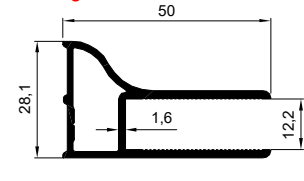
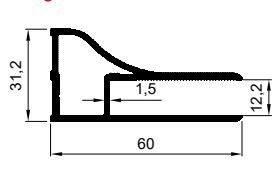
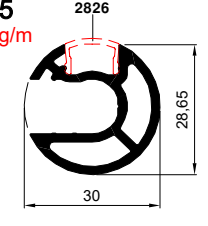
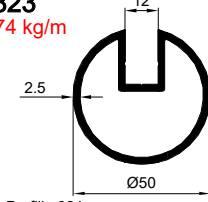
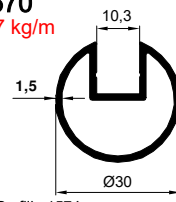
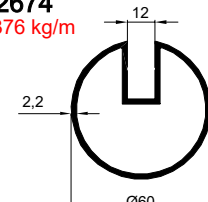
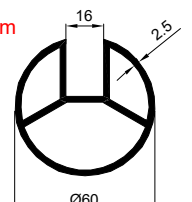
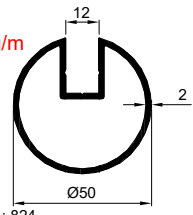
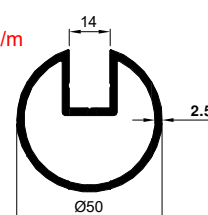
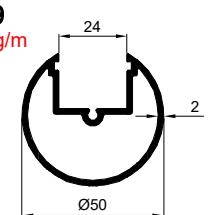
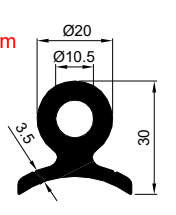
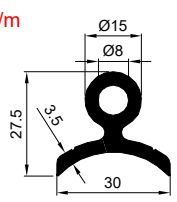
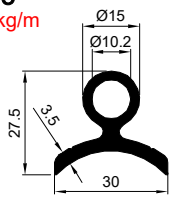
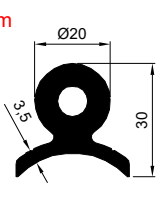
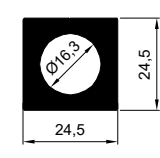
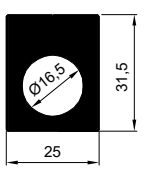
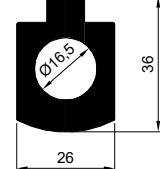
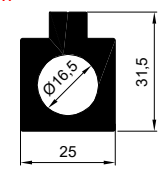
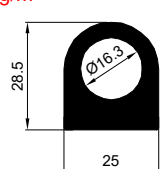
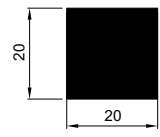
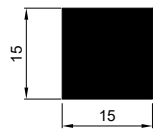
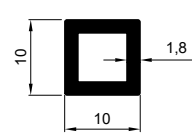
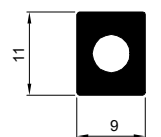
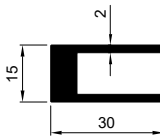
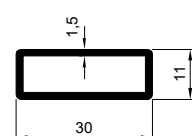
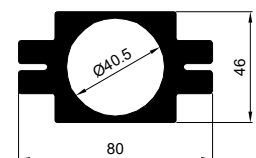
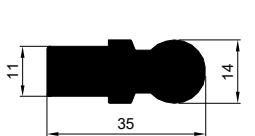

YUVARLAK KÜPEŞTE PROFİLLERİ

HANDRAIL PROFILES (ROUND)

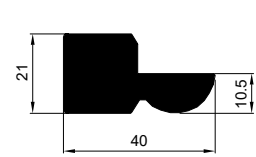
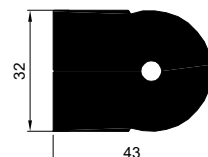
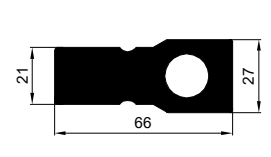
8781 0.775 kg/m 	8780 0.684 kg/m 	10066 0.843 kg/m 	2825 0.599 kg/m 
823 1.274 kg/m  Kapak Profili : 824 Cover Profile : 824	1570 0.467 kg/m  Kapak Profili : 1574 Cover Profile : 1574	2674 1.376 kg/m 	636 1.812 kg/m 
4723 1.026 kg/m  Kapak Profili : 824 Cover Profile : 824	5697 1.270 kg/m 	3809 1.050 kg/m 	1187 0.979 kg/m 
3114 0.692 kg/m 	3115 0.607 kg/m 	1208 1.049 kg/m 	4727 1.061 kg/m 
2752 1.554 kg/m 	2058 1.579 kg/m 	962 1.269 kg/m 	3075 1.183 kg/m 
1021 1.084 kg/m 	1030 0.609 kg/m 	1576 0.160 kg/m 	1026 0.213 kg/m 
3754 0.534 kg/m 	2824 0.307 kg/m 	4342 4.338 kg/m 	5942 1.095 kg/m 
5940 4.274 kg/m 	5941 1.574 kg/m 	6805 3.355 kg/m 	6479 3.589 kg/m 



YUVARLAK KÜPEŞTE PROFİLLERİ HANDRAIL PROFILES (ROUND)

2655 5.666 kg/m 	6478 4.887 kg/m 	4339 7.775 kg/m 	594 2.926 kg/m
963 2.533 kg/m 	8096 1.982 kg/m 	8432 2.033 kg/m 	2951 1.786 kg/m
5761 1.353 kg/m 	538 7.410 kg/m 	1223 0.375 kg/m 	5760 0.848 kg/m
5759 1.047 kg/m 	5758 5.185 kg/m 	5397 1.047 kg/m 	3797 0.705 kg/m
3799 1.425 kg/m 	3798 0.972 kg/m 	1590 1.619 kg/m 	2953 2.281 kg/m
8915 1.809 kg/m 	5721 2.828 kg/m 	970 6.042 kg/m 	969 4.159 kg/m
971 7.387 kg/m 	972 8.732 kg/m 	8110 20.389 kg/m 	1231 10.130 kg/m
1408 7.987 kg/m 	4040 5.655 kg/m 	2547 4.574 kg/m 	1037 4.303 kg/m



YUVARLAK KÜPEŞTE PROFİLLERİ

HANDRAIL PROFILES (ROUND)

8371 1.979 kg/m 	496 4.377 kg/m 	2714 2.564 kg/m 	537 5.724 kg/m
975 1.642 kg/m 	494 3.185 kg/m 	2647 2.844 kg/m 	2939 3.636 kg/m
1393 2.418 kg/m 	4724 3.247 kg/m 	941 3.767 kg/m 	1591 2.485 kg/m
2651 3.985 kg/m 	4795 2.986 kg/m 	2715 5.155 kg/m 	4069 2.556 kg/m
1394 1.185 kg/m 	2680 2.265 kg/m 	2850 1.422 kg/m 	2549 1.428 kg/m
1013 3.092 kg/m 	1589 2.971 kg/m 	1587 3.074 kg/m 	4829 2.361 kg/m
4028 1.975 kg/m 	2699 2.603 kg/m 	2833 2.582 kg/m 	3761 1.859 kg/m
495 2.343 kg/m 	1597 2.189 kg/m 	1598 1.957 kg/m 	2729 1.093 kg/m





YUVARLAK KÜPEŞTE PROFİLLERİ HANDRAIL PROFILE (ROUND)

1008 1.223 kg/m 	2530 0.855 kg/m 	2712 1.023 kg/m 	2981 0.786 kg/m
5757 0.754 kg/m 	1203 0.876 kg/m 	3899 0.733 kg/m 	5902 0.883 kg/m
2656 3.005 kg/m 	2881 3.102 kg/m 	2980 2.643 kg/m 	4340 2.551 kg/m
2686 3.667 kg/m 	499 3.558 kg/m 	2191 4.040 kg/m 	4726 2.281 kg/m
4100 3.272 kg/m 	2844 2.740 kg/m 	2567 2.996 kg/m 	5959 2.609 kg/m
8942 2.570 kg/m 	2057 3.514 kg/m 	3760 2.539 kg/m 	6462 2.232 kg/m
6684 3.911 kg/m 	6685 3.013 kg/m 	2065 3.610 kg/m 	6167 3.731 kg/m
8941 2.697 kg/m 	2689 3.211 kg/m 	6168 3.872 kg/m 	3759 2.616 kg/m

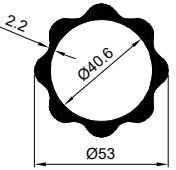
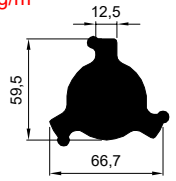
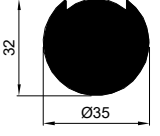
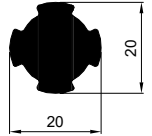
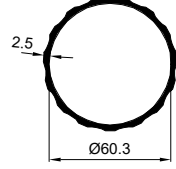
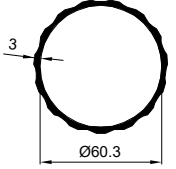
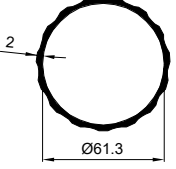
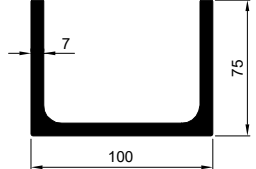
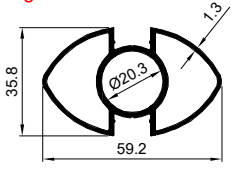

YUVARLAK KÜPEŞTE PROFİLLERİ

HANDRAIL PROFILES (ROUND)

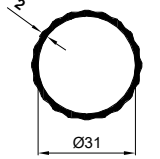
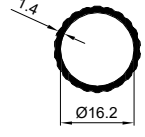
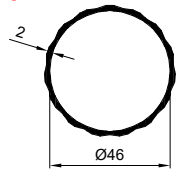
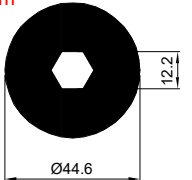
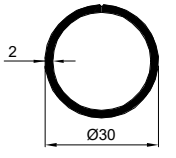
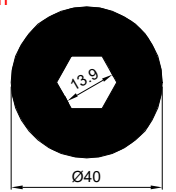
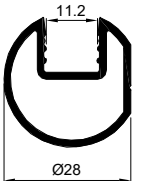
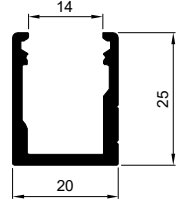
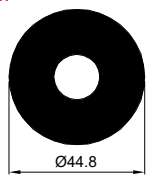
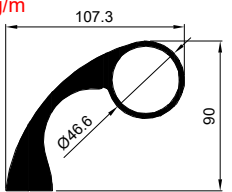
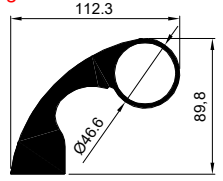
<p>5370 1.665 kg/m</p> 	<p>8906 6.007 kg/m</p> 	<p>2654 2.432 kg/m</p> 	<p>4061 0.714 kg/m</p> 
<p>6023 1.266 kg/m</p> 	<p>1036 1.377 kg/m</p> 	<p>10371 1.008 kg/m</p> 	<p>2830 4.590 kg/m</p> 
<p>4957 0.878 kg/m</p> 	<p>2831 5.538 kg/m</p> 	<p>6493 0.482 kg/m</p> 	<p>6494 0.190 kg/m</p> 
<p>6492 0.675 kg/m</p> 	<p>5744 3.885 kg/m</p> 	<p>6174 0.476 kg/m</p> 	<p>3082 2.955 kg/m</p> 
<p>13136 0.460 kg/m</p> 	<p>13137 0.397 kg/m</p> 	<p>616 3.824 kg/m</p> 	<p>385 5.067 kg/m</p> 
<p>2784 6.753 kg/m</p> 			



KARE KÜPEŞTE PROFİLLERİ

HANDRAIL PROFILES (RECTANGULAR, ROUND)

4107 1.041 kg/m 	6610 0.887 kg/m 	4893 0.926 kg/m 	5376 0.873 kg/m
4122 1.037 kg/m 	5764 0.857 kg/m 	3627 0.842 kg/m 	4096 1.072 kg/m
3628 1.108 kg/m 	4162 1.013 kg/m 	3626 0.976 kg/m 	6813 0.854 kg/m
10281 0.847 kg/m 	10280 0.773 kg/m 	6816 0.792 kg/m 	7423 1.176 kg/m
6617 1.071 kg/m 	6974 0.816 kg/m 	3133 0.860 kg/m 	7112 1.069 kg/m
3629 1.271 kg/m 	1000 1.149 kg/m 	5989 1.217 kg/m 	6814 1.076 kg/m
5677 1.166 kg/m 	1399 1.374 kg/m 	3631 1.183 kg/m 	4894 1.211 kg/m
4761 1.344 kg/m 	6611 1.132 kg/m 	5631 1.355 kg/m 	6454 1.127 kg/m



KARE KÜPEŞTE PROFİLLERİ

HANDRAIL PROFILES (RECTANGULAR, ROUND)

3630 1.397 kg/m 	6618 1.360 kg/m 	6771 1.154 kg/m 	6267 1.154 kg/m
6615 1.459 kg/m 	4111 1.193 kg/m 	6683 2.345 kg/m 	7634 1.261 kg/m
3624 0.949 kg/m 	6268 1.492 kg/m 	4760 1.852 kg/m 	6772 1.484 kg/m
6614 1.027 kg/m 	3625 1.201 kg/m 	6269 1.997 kg/m 	5325 2.230 kg/m
6272 2.402 kg/m 	6271 1.995 kg/m 	4762 2.638 kg/m 	5324 2.634 kg/m
6270 2.404 kg/m 	6274 2.390 kg/m 	5983 1.182 kg/m 	3134 6.279 kg/m
7859 0.424 kg/m 	4110 6.616 kg/m 	7855 0.960 kg/m 	7856 0.699 kg/m
8431 1.126 kg/m 	7858 0.251 kg/m 	7857 0.167 kg/m 	6613 0.572 kg/m



KARE KÜPEŞTE PROFİLLERİ

HANDRAIL PROFILES (RECTANGULAR, ROUND)

<p>1023 7.662 kg/m</p> <p>Ø60</p>	<p>4333 1.106 kg/m</p> <p>74.6 36.6 2</p>	<p>4895 20.783 kg/m</p> <p>70 120</p>	<p>5735 0.644 kg/m</p> <p>6 43</p>
<p>5734 1.050 kg/m</p> <p>13 18 6 43</p>	<p>6767 0.735 kg/m</p> <p>12.2 40 Ø20.4 25</p> <p>Kapak Profili : 592 Cover Profile : 592</p>	<p>7114 0.704 kg/m</p> <p>13.2 40 Ø20.3 25</p> <p>Kapak Profili : 7301 Cover Profile : 7301</p>	<p>4335 0.996 kg/m</p> <p>14.2 35 1.8 35</p> <p>Kapak Profili : 1411 Cover Profile : 1411</p>
<p>5763 0.911 kg/m</p> <p>12.2 40 1.3 40</p> <p>Kapak Profili : 592 Cover Profile : 592</p>	<p>5434 1.020 kg/m</p> <p>12.2 40 1.5 40</p> <p>Kapak Profili : 592 Cover Profile : 592</p>	<p>7113 0.869 kg/m</p> <p>13.2 40 1.3 40</p> <p>Kapak Profili : 7301 Cover Profile : 7301</p>	<p>7115 0.945 kg/m</p> <p>13.2 40 1.3 40</p> <p>Kapak Profili : 7301 Cover Profile : 7301</p>
<p>1410 1.188 kg/m</p> <p>14.2 40 1.8 40</p> <p>Kapak Profili : 1411 Cover Profile : 1411</p>	<p>5679 1.014 kg/m</p> <p>14.2 40 1.5 40</p> <p>Kapak Profili : 1411 Cover Profile : 1411</p>	<p>5678 1.046 kg/m</p> <p>14.2 40 1.5 40</p> <p>Kapak Profili : 1411 Cover Profile : 1411</p>	<p>590 1.209 kg/m</p> <p>12.2 40 1.8 40</p> <p>Kapak Profili : 592 Cover Profile : 592</p>
<p>4699 1.156 kg/m</p> <p>40 14.2 1.8 40</p> <p>Kapak Profili : 1411 Cover Profile : 1411</p>	<p>591 1.183 kg/m</p> <p>40 12.2 1.8 40</p> <p>Kapak Profili : 592 Cover Profile : 592</p>	<p>1409 0.258 kg/m</p> <p>14 2 14</p>	<p>9698 0.201 kg/m</p> <p>14 1.5 14</p>
<p>5637 0.200 kg/m</p> <p>17.4 1.2 17.4</p>	<p>4106 0.851 kg/m</p> <p>30.4 2.5 37.4</p>	<p>4336 2.193 kg/m</p> <p>45.5 5 45.5</p>	<p>4123 1.879 kg/m</p> <p>48.4 3.9 48.4</p>
<p>5984 1.249 kg/m</p> <p>28.4 3 66.4</p>	<p>4103 3.374 kg/m</p> <p>53.8 6.6 53.8</p>	<p>7350 0.557 kg/m</p> <p>25 1.3 40</p>	<p>6612 0.478 kg/m</p> <p>31.8 2 24.6</p>
<p>4898 1.427 kg/m</p> <p>36.6 3.1 56.6</p>	<p>4109 0.905 kg/m</p> <p>55 9 14</p>	<p>7101 4.051 kg/m</p> <p>25.2 60.2</p>	<p>12776 2.745 kg/m</p> <p>37 30</p>



KARE KÜPEŞTE PROFİLLERİ

HANDRAIL PROFILES (RECTANGULAR, ROUND)

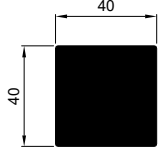
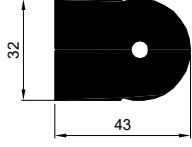
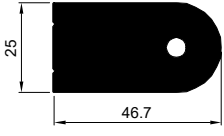
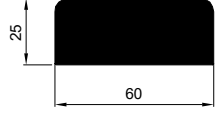
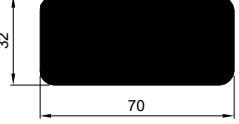
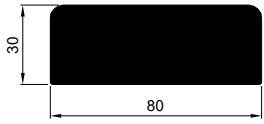
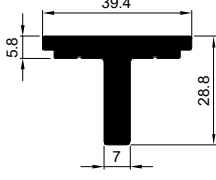
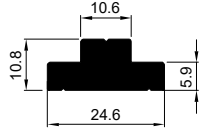
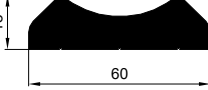
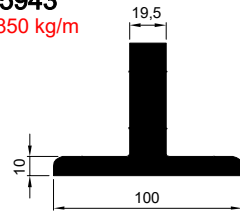
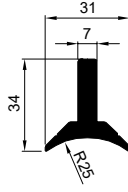
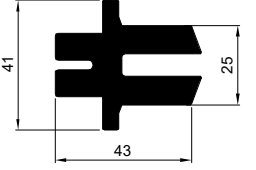
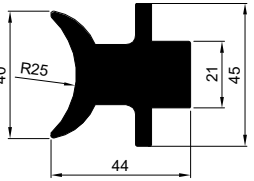
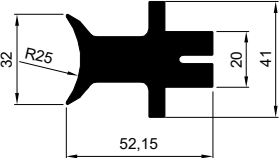
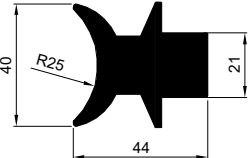
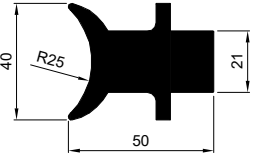
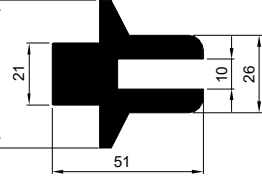
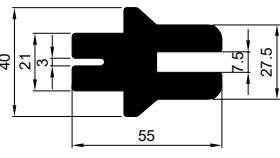
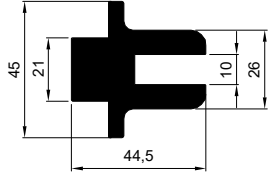
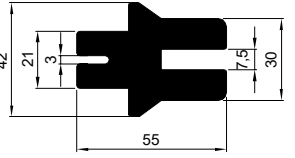
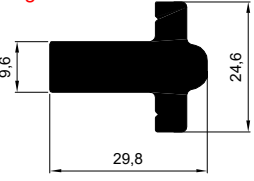
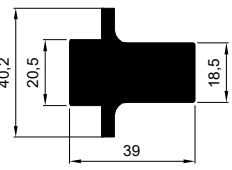
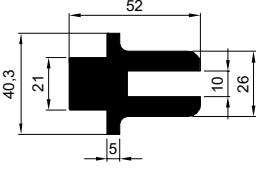
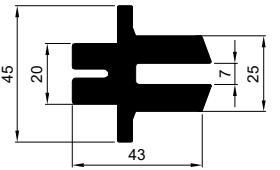
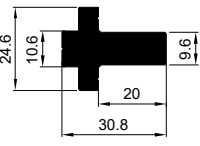
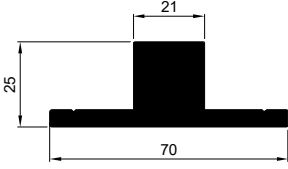
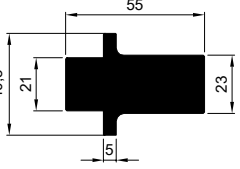
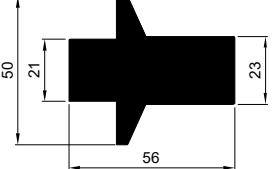
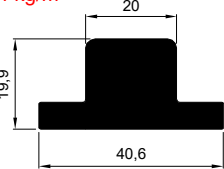
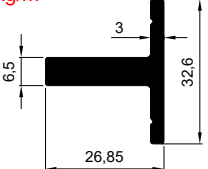
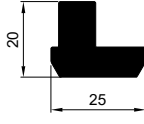
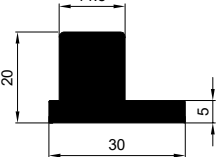
4102 4.334 kg/m 	6805 3.355 kg/m 	4132 2.916 kg/m 	4116 4.036 kg/m 
4341 6.012 kg/m 	5639 6.474 kg/m 	4125 1.020 kg/m 	4108 0.531 kg/m 
4129 2.128 kg/m 	5943 5.850 kg/m 	2530 0.855 kg/m 	12837 2.497 kg/m 
8941 2.697 kg/m 	7338 2.669 kg/m 	3759 2.616 kg/m 	4767 3.044 kg/m 
6685 3.013 kg/m 	4159 3.438 kg/m 	8942 2.570 kg/m 	2686 3.667 kg/m 
6812 0.991 kg/m 	7349 2.263 kg/m 	4764 2.849 kg/m 	4340 2.551 kg/m 
4114 1.053 kg/m 	7389 2.084 kg/m 	4763 3.664 kg/m 	6684 3.911 kg/m 
12868 1.404 kg/m 	6278 0.683 kg/m 	4161 0.835 kg/m 	5950 0.995 kg/m 



KARE KÜPEŞTE PROFİLLERİ

HANDRAIL PROFILES (RECTANGULAR, ROUND)

4897 0.420 kg/m 	4954 8.603 kg/m 	5949 0.724 kg/m 	4896 4.706 kg/m
4337 0.722 kg/m 	4101 0.529 kg/m 	4115 1.456 kg/m 	4127 1.288 kg/m
5791 0.153 kg/m 	4766 0.653 kg/m 	4118 13.228 kg/m 	7261 13.659 kg/m
4117 2.437 kg/m 	4953 2.573 kg/m 	5638 0.796 kg/m 	5948 0.932 kg/m
4105 0.588 kg/m 	5990 0.571 kg/m 	4104 0.391 kg/m 	4097 0.420 kg/m
<small>Kapak Profili : 4112 Cover Profile : 4112</small>	<small>Kapak Profili : 5992 Cover Profile : 5992</small>		<small>Kapak Profili : 4099 Cover Profile : 4099</small>
7301 0.087 kg/m 	1411 0.080 kg/m 	592 0.073 kg/m 	4099 0.094 kg/m
5991 0.108 kg/m 	6616 0.155 kg/m 	4112 0.078 kg/m 	5992 0.080 kg/m
4113 0.108 kg/m 	7311 0.528 kg/m 	5765 0.302 kg/m 	4765 0.763 kg/m



KARE KÜPEŞTE PROFİLLERİ

HANDRAIL PROFILES (RECTANGULAR, ROUND)

<p>6680 0.575 kg/m</p> <p>Kapak Profili : 7241 Cover Profile:7241</p>	<p>7241 0.084 kg/m</p> <p>Kapak Profili : 7241 Cover Profile:7241</p>	<p>7251 0.454 kg/m</p> <p>Kapak Profili : 7241 Cover Profile:7241</p>	<p>6273 1.765 kg/m</p> <p>Kapak Profili : 7241 Cover Profile:7241</p>
<p>7252 0.857 kg/m</p> <p>Kapak Profili : 7241 Cover Profile:7241</p>	<p>7850 0.760 kg/m</p> <p>Kapak Profili : 4113 Cover Profile:4113</p>	<p>7242 1.149 kg/m</p> <p>Kapak Profili : 4113-7241 Cover Profile:4113-7241</p>	<p>6985 1.315 kg/m</p> <p>Kapak Profili : 7241 Cover Profile:7241</p>
<p>6169 1.726 kg/m</p> <p>Kapak Profili : 4113 Cover Profile:4113</p>	<p>7854 2.081 kg/m</p> <p>Kapak Profili : 4113 Cover Profile:7241</p>	<p>7851 1.084 kg/m</p> <p>Kapak Profili : 4113 Cover Profile:4113</p>	<p>7253 0.872 kg/m</p> <p>Kapak Profili : 7241 Cover Profile:7241</p>
<p>8931 1.698 kg/m</p> <p>Kapak Profili : 4099-4113 Cover Profile:4099-4113</p>	<p>12615 0.613 kg/m</p> <p>Kapak Profili : 4099-4113 Cover Profile:4099-4113</p>	<p>12536 0.849 kg/m</p> <p>Kapak Profili : 4099-4113 Cover Profile:4099-4113</p>	<p>6974 0.816 kg/m</p> <p>Kapak Profili : 4099-4113 Cover Profile:4099-4113</p>
<p>12619 0.794 kg/m</p> <p>Kapak Profili : 4099-4113 Cover Profile:4099-4113</p>	<p>12620 0.166 kg/m</p> <p>Kapak Profili : 4099-4113 Cover Profile:4099-4113</p>	<p>12616 0.495 kg/m</p> <p>Kapak Profili : 4099-4113 Cover Profile:4099-4113</p>	<p>12618 0.614 kg/m</p> <p>Kapak Profili : 4099-4113 Cover Profile:4099-4113</p>
<p>12725 1.619 kg/m</p> <p>Kapak Profili : 4099-4113 Cover Profile:4099-4113</p>	<p>12617 0.659 kg/m</p> <p>Kapak Profili : 4099-4113 Cover Profile:4099-4113</p>	<p>12471 0.510 kg/m</p> <p>Kapak Profili : 4099-4113 Cover Profile:4099-4113</p>	<p>12544 2.020 kg/m</p> <p>Kapak Profili : 4099-4113 Cover Profile:4099-4113</p>
<p>8342 1.016 kg/m</p> <p>Kapak Profili : 7301 Cover Profile:7301</p>	<p>6635 1.321 kg/m</p> <p>Kapak Profili : 7301 Cover Profile:7301</p>	<p>5636 1.519 kg/m</p> <p>Kapak Profili : 7301 Cover Profile:7301</p>	<p>12472 0.774 kg/m</p> <p>Kapak Profili : 7301 Cover Profile:7301</p>
<p>7852 0.325 kg/m</p> <p>Kapak Profili : 1411 Cover Profile:1411</p>	<p>7853 1.565 kg/m</p> <p>Kapak Profili : 1411 Cover Profile:1411</p>	<p>8433 0.240 kg/m</p> <p>Kapak Profili : 1411 Cover Profile:1411</p>	<p>6099 1.046 kg/m</p> <p>Kapak Profili : 1411 Cover Profile:1411</p>



KARE KÜPEŞTE PROFİLLERİ HANDRAIL PROFILE (RECTANGULAR, ROUND)

<p>6679 1.120 kg/m</p> <p>Kapak Profili : 7241 Cover Profile: 7241</p>	<p>8338 0.403 kg/m</p> <p>Kapak Profili : 4099 Cover Profile: 4099</p>	<p>6681 1.566 kg/m</p> <p></p>	<p>7351 0.779 kg/m</p> <p></p>
<p>12281 0.234 kg/m</p> <p></p>	<p>8403 0.173 kg/m</p> <p></p>	<p>8791 0.206 kg/m</p> <p></p>	<p>6682 1.873 kg/m</p> <p></p>
<p>3902 11.975 kg/m</p> <p></p>	<p>5721 2.828 kg/m</p> <p></p>	<p>4160 2.303 kg/m</p> <p></p>	<p>4119 2.283 kg/m</p> <p></p>
<p>3900 1.639 kg/m</p> <p></p>	<p>4338 4.247 kg/m</p> <p></p>	<p>12775 1.144 kg/m</p> <p></p>	<p>4121 5.782 kg/m</p> <p></p>
<p>12870 0.885 kg/m</p> <p></p>			











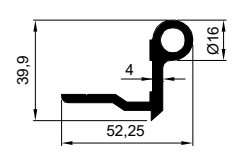
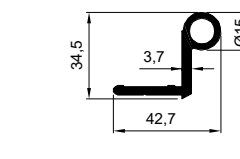
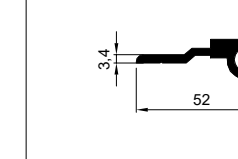
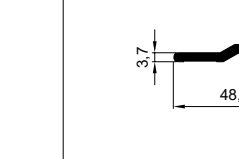
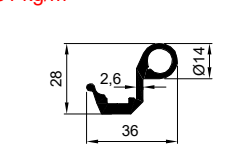
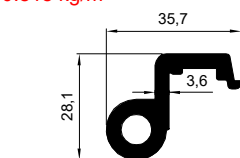
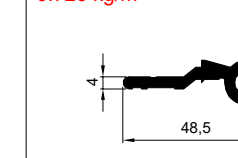

LR70-LR100-LR125 KÜPEŞTE PROFİLLERİ

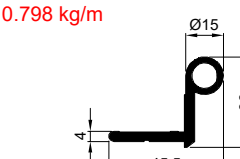
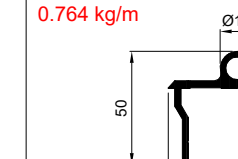
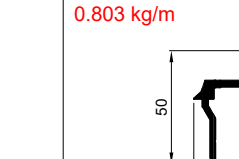
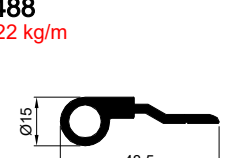
HANDRAIL PROFILES

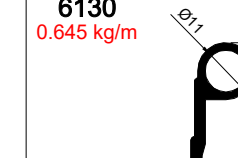
<p>13079 2.767 kg/m</p> <p>LR70</p>	<p>13080 0.457 kg/m</p> <p>LR70</p>	<p>12466 3.909 kg/m</p> <p>LR100</p>	<p>11880 4.600 kg/m</p> <p>LR125</p>
<p>12153 0.947 kg/m</p> <p>LR70</p>	<p>12150 0.728 kg/m</p> <p>LR70</p>	<p>12151 0.621 kg/m</p> <p>LR100</p>	<p>12152 1.002 kg/m</p> <p>LR125</p>
<p>12418 0.960 kg/m</p> <p>LR70</p>	<p>12154 0.816 kg/m</p> <p>LR70</p>	<p>12155 0.767 kg/m</p> <p>LR100</p>	<p>10169 1.052 kg/m</p> <p>LR125</p>
<p>12156 1.077 kg/m</p> <p>LR70</p>	<p>12157 1.061 kg/m</p> <p>LR70</p>	<p>12417 1.291 kg/m</p> <p>LR100</p>	<p>12158 0.293 kg/m</p> <p>LR70</p>
<p>12159 0.382 kg/m</p> <p>LR70</p>	<p>1022 0.073 kg/m</p> <p>LR70</p>	<p>592 0.073 kg/m</p> <p>LR70</p>	<p>8403 0.173 kg/m</p> <p>LR70</p>
<p>8791 0.206 kg/m</p> <p>LR70</p>	<p>12281 0.234 kg/m</p> <p>LR70</p>		

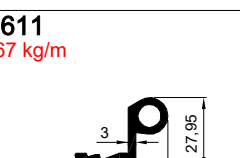
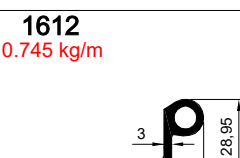
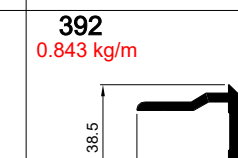
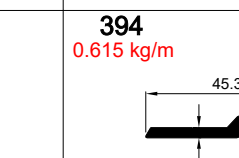
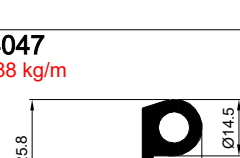
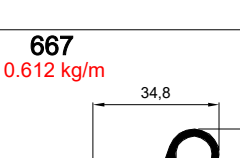
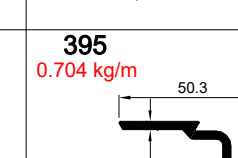
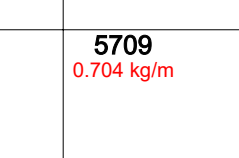
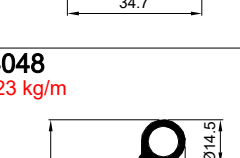

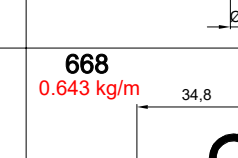
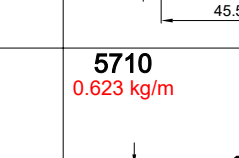
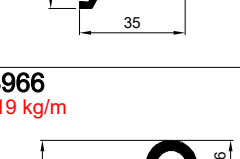
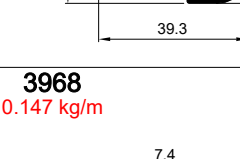
AKSESUAR PROFİLLERİ ACCESSORY PROFILES

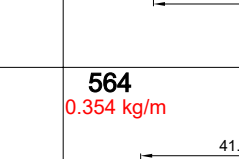
445 0.984 kg/m 	449 0.731 kg/m 	448 0.765 kg/m 	450 0.720 kg/m 
2145 0.581 kg/m 	1683 0.818 kg/m 	440 0.726 kg/m 	1610 0.730 kg/m 
1682 0.810 kg/m 	442 0.798 kg/m 	487 0.764 kg/m 	486 0.803 kg/m 
488 0.622 kg/m 	393 0.658 kg/m 	6130 0.645 kg/m 	6129 0.635 kg/m 
1611 0.667 kg/m 	1612 0.745 kg/m 	392 0.843 kg/m 	394 0.615 kg/m 
4047 0.688 kg/m 	667 0.612 kg/m 	395 0.704 kg/m 	5709 0.704 kg/m 
4048 0.623 kg/m 	3967 0.896 kg/m 	668 0.643 kg/m 	5710 0.623 kg/m 
3966 0.819 kg/m 	3968 0.147 kg/m 	3969 0.148 kg/m 	564 0.354 kg/m 



AKSESUAR PROFİLLERİ

ACCESSORY PROFILES

2800 0.488 kg/m 	6827 0.629 kg/m 	1921 0.386 kg/m 	1976 0.430 kg/m
1753 0.564 kg/m 	1752 0.640 kg/m 	6826 0.620 kg/m 	2151 3.437 kg/m
464 0.754 kg/m 	482 3.047 kg/m 	463 2.701 kg/m 	2155 0.333 kg/m
461 1.914 kg/m 	462 0.638 kg/m 	2140 0.536 kg/m 	2150 2.217 kg/m
483 0.604 kg/m 	484 2.469 kg/m 	485 0.392 kg/m 	4043 2.764 kg/m
4044 0.840 kg/m 	4045 2.130 kg/m 	4046 0.714 kg/m 	1613 0.080 kg/m
1054 0.700 kg/m 	1055 1.485 kg/m 	1056 0.399 kg/m 	348 0.214 kg/m
5675 0.142 kg/m 	3904 2.167 kg/m 	1606 1.315 kg/m 	1608 0.848 kg/m



AKSESUAR PROFİLLERİ

ACCESSORY PROFILES

900 2.567 kg/m 	2734 0.586 kg/m 	125 0.423 kg/m 	1600 1.632 kg/m
498 3.314 kg/m 	347 1.065 kg/m 	352 2.063 kg/m 	1601 2.509 kg/m
346 0.269 kg/m 	2061 1.662 kg/m 	5673 0.323 kg/m 	5674 0.433 kg/m
436 0.328 kg/m 	350 0.968 kg/m 	4066 0.229 kg/m 	1602 0.387 kg/m
354 1.430 kg/m 	2146 0.151 kg/m 	437 0.354 kg/m 	349 0.538 kg/m
2585 0.460 kg/m 	2732 1.706 kg/m 	2738 10.112 kg/m 	3907 4.982 kg/m
497 4.455 kg/m 	3906 0.504 kg/m 	355 0.501 kg/m 	351 0.335 kg/m
12511 2.252 kg/m 	10292 0.664 kg/m 	11414 0.865 kg/m 	11415 0.845 kg/m



ÖZEL PROFİLLER SPECIAL PROFILES

202 23.705 kg/m 	2648 16.474 kg/m 	2709 25.300 kg/m 	2178 29.834 kg/m
6098 21.248 kg/m 	8059 27.035 kg/m 	318 4.073 kg/m 	207 5.162 kg/m
1541 3.297 kg/m 	6266 4.057 kg/m 	2970 8.390 kg/m 	1412 0.671 kg/m
3746 0.234 kg/m 	3138 1.062 kg/m 	4780 0.256 kg/m 	2164 9.813 kg/m
1213 2.558 kg/m 	2213 0.559 kg/m 	2214 0.577 kg/m 	1212 3.512 kg/m
6423 0.142 kg/m 	2834 0.927 kg/m 	2835 1.180 kg/m 	2836 0.352 kg/m
1067 0.241 kg/m 	227 0.307 kg/m 	4307 0.388 kg/m 	4041 0.426 kg/m
4308 0.446 kg/m 	4042 0.485 kg/m 	7345 0.413 kg/m 	6449 0.459 kg/m

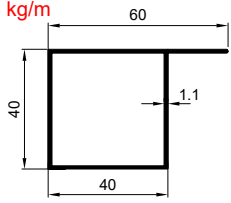
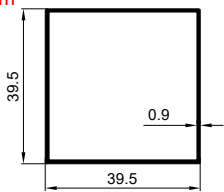
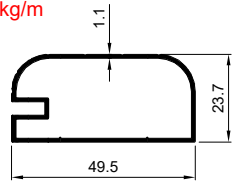
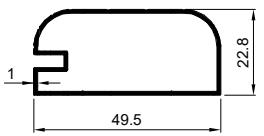
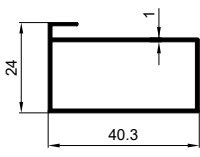
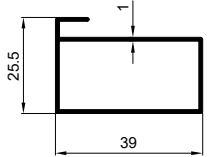
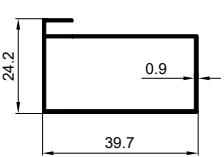
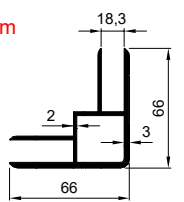
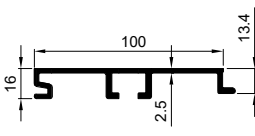
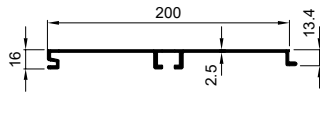
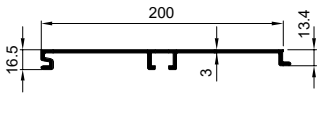
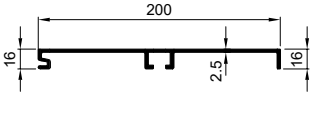
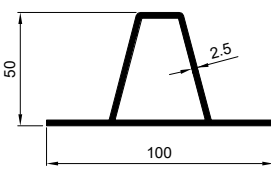
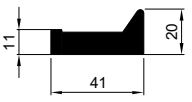
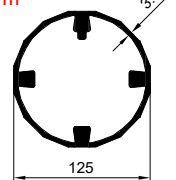
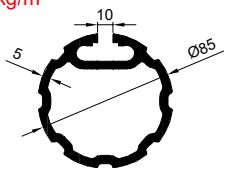
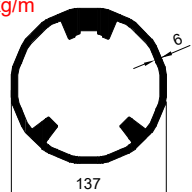
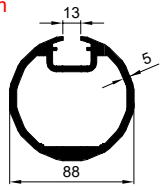
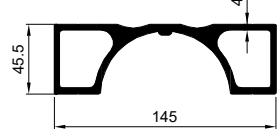
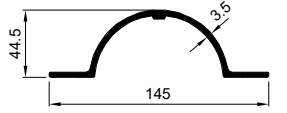
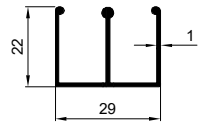
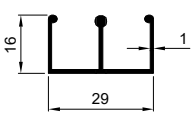
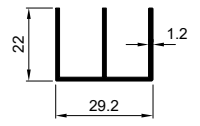
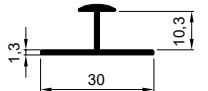
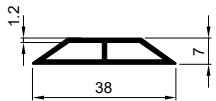
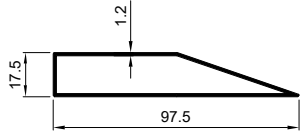
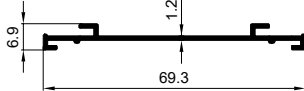
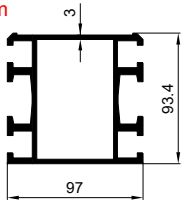
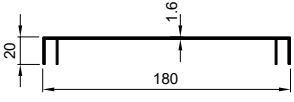
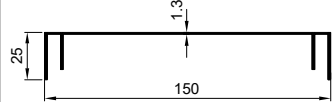
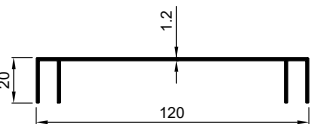
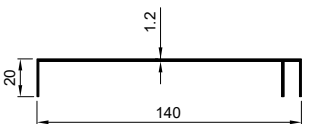

ÖZEL PROFİLLER SPECIAL PROFILES

6464 0.523 kg/m 	7346 0.377 kg/m 	5328 0.449 kg/m 	4309 0.400 kg/m 
6451 0.344 kg/m 	5718 0.349 kg/m 	7347 0.310 kg/m 	5714 1.676 kg/m 
1529 1.266 kg/m 	1525 1.942 kg/m 	3965 2.249 kg/m 	1526 1.908 kg/m 
1528 1.444 kg/m 	4674 1.279 kg/m 	1522 6.536 kg/m 	1524 4.178 kg/m 
4672 10.068 kg/m 	4673 4.456 kg/m 	1521 4.474 kg/m 	1523 1.852 kg/m 
5649 0.276 kg/m 	5650 0.227 kg/m 	512 0.298 kg/m 	2829 0.181 kg/m 
2828 0.257 kg/m 	2827 0.682 kg/m 	5911 0.312 kg/m 	5958 4.846 kg/m 
801 1.099 kg/m 	3817 0.825 kg/m 	2237 0.634 kg/m 	2238 0.638 kg/m 



ÖZEL PROFİLLER SPECIAL PROFILES

<p>3475 0.580 kg/m</p>	<p>560 0.713 kg/m</p>	<p>997 1.755 kg/m</p>	<p>1450 0.875 kg/m</p>
<p>191 1.840 kg/m</p>	<p>6422 1.196 kg/m</p>	<p>3137 1.094 kg/m</p>	<p>6998 0.910 kg/m</p>
<p>3652 0.514 kg/m</p>	<p>3653 0.578 kg/m</p>	<p>3654 0.745 kg/m</p>	<p>3655 0.949 kg/m</p>
<p>3656 1.006 kg/m</p>	<p>3657 0.808 kg/m</p>	<p>3658 0.244 kg/m</p>	<p>7335 1.935 kg/m</p>
<p>7336 2.719 kg/m</p>	<p>8054 0.795 kg/m</p>	<p>9791 0.096 kg/m</p>	<p>153 0.308 kg/m</p>
<p>9694 0.773 kg/m</p>	<p>12099 0.530 kg/m</p>	<p>11489 0.387 kg/m</p>	<p>8455 0.756 kg/m</p>
<p>9893 5.790 kg/m</p>	<p>2408 0.301 kg/m</p>	<p>2019 0.460 kg/m</p>	



ALDOKS SERİSİ

ALDOKS SERIES

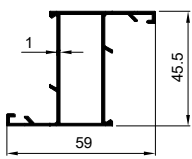
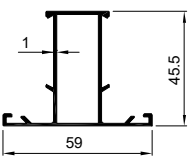
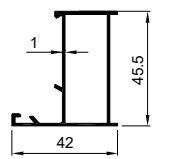
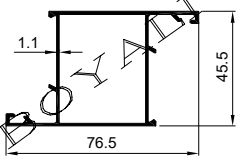
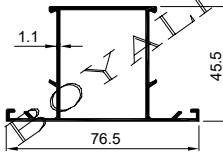
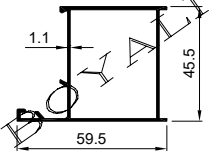
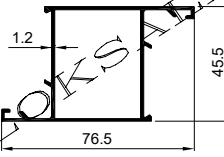
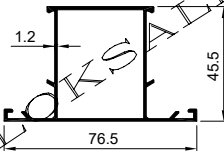
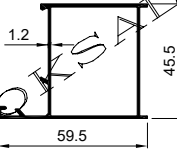
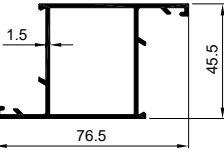
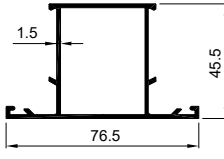
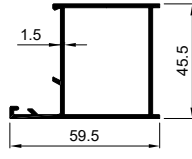
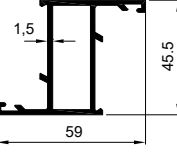
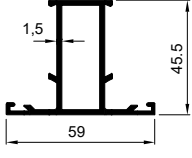
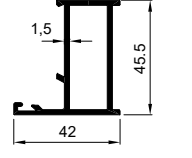
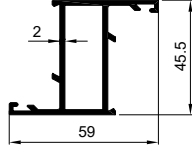
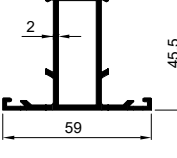
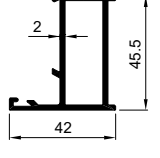
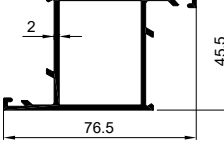
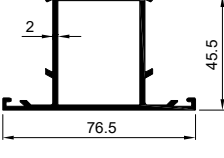
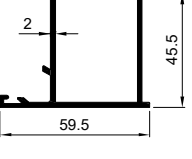
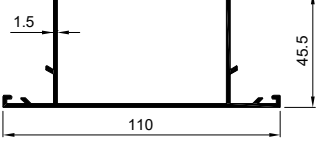
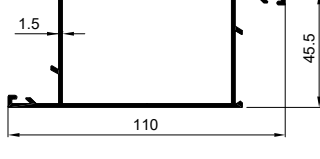
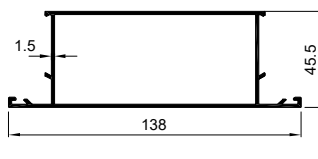
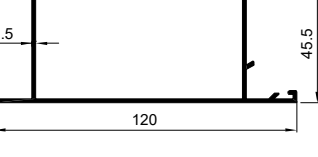
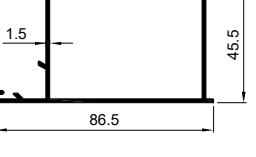
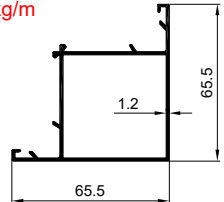
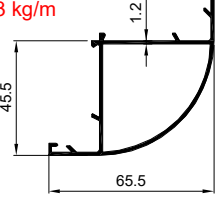
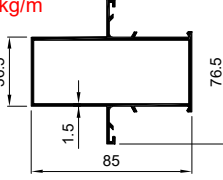
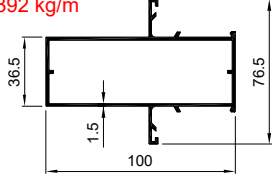
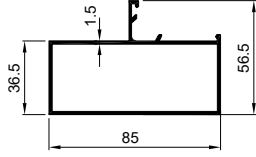
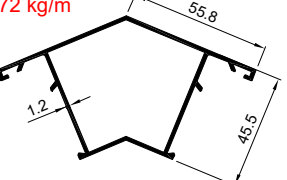
178 0.556 kg/m 	179 0.556 kg/m 	180 0.464 kg/m 	20181 0.710 kg/m 
20182 0.710 kg/m 	20183 0.610 kg/m 	181 0.766 kg/m 	182 0.766 kg/m 
183 0.661 kg/m 	401 0.935 kg/m 	402 0.935 kg/m 	403 0.813 kg/m 
624 0.793 kg/m 	625 0.793 kg/m 	626 0.671 kg/m 	337 0.990 kg/m 
338 0.990 kg/m 	339 0.854 kg/m 	340 1.179 kg/m 	341 1.179 kg/m 
342 1.045 kg/m 	185 1.208 kg/m 	198 1.206 kg/m 	186 1.434 kg/m 
184 1.325 kg/m 	424 1.032 kg/m 	6832 0.824 kg/m 	159 0.763 kg/m 
109 1.260 kg/m 	110 1.392 kg/m 	391 1.112 kg/m 	160 0.872 kg/m 



ALDOKS SERİSİ

ALDOKS SERIES

404 1.728 kg/m 	7397 0.590 kg/m 	267 0.776 kg/m 	7435 0.787 kg/m
5344 0.849 kg/m 	415 1.041 kg/m 	8472 1.140 kg/m 	501 0.903 kg/m
504 0.787 kg/m 	3949 1.529 kg/m 	8473 1.050 kg/m 	505 0.194 kg/m
502 0.225 kg/m 	4095 0.533 kg/m 	640 0.125 kg/m 	639 0.132 kg/m
1209 0.380 kg/m 	1210 0.298 kg/m 	158 0.203 kg/m 	157 0.291 kg/m
105 0.221 kg/m 	5987 0.222 kg/m 	104 0.234 kg/m 	384 0.230 kg/m
3818 0.210 kg/m 	1121 0.232 kg/m 	1035 0.239 kg/m 	1139 0.239 kg/m
6414 0.175 kg/m 	5788 0.205 kg/m 	140 0.560 kg/m 	225 0.635 kg/m



ALDOKS SERİSİ

ALDOKS SERIES

<p>190 1.816 kg/m</p> <p>185 ve 198 nolu profillerin köşe bağlantısı Corner connection for profiles 185 and 198</p>	<p>607 1.729 kg/m</p> <p>424 nolu profilin köşe bağlantısı Corner connection for profiles 424</p>	<p>151 1.081 kg/m</p> <p>181-182-183 nolu profillerin köşe bağlantısı Corner connection for profiles 181-182-183</p>	<p>152 0.710 kg/m</p> <p>178-179-180 nolu profillerin köşe bağlantısı Corner connection for profiles 178-179-180</p>
<p>295 0.715 kg/m</p> <p>337-338-339 nolu profillerin köşe bağlantısı Corner connection for profiles 337-338-339</p>	<p>381 1.083 kg/m</p> <p>401-402-403 nolu profillerin köşe bağlantısı Corner connection for profiles 401-402-403</p>	<p>383 1.075 kg/m</p> <p>340,341,342 nolu profillerin köşe bağlantısı Corner connection for profiles 340-341-342</p>	<p>481 0.183 kg/m</p> <p>481 nolu profilin köşe bağlantısı Corner connection for profiles 481</p>
<p>5387 0.493 kg/m</p> <p>5387 nolu profilin köşe bağlantısı Corner connection for profiles 5387</p>	<p>1579 0.500 kg/m</p> <p>1579 nolu profilin köşe bağlantısı Corner connection for profiles 1579</p>		



TS29 TUBA SÜRME SERİSİ (67 mm)

TS29 TUBA SLIDING SERIES (67 mm)

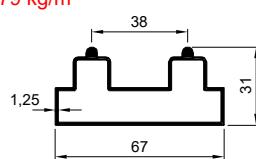
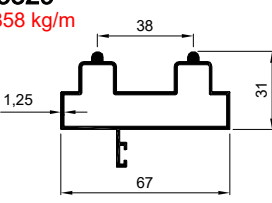
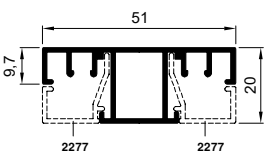
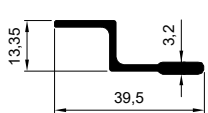
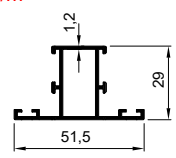
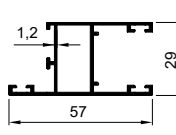
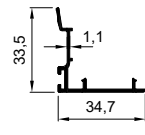
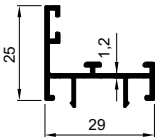
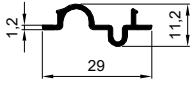
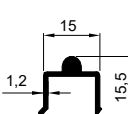
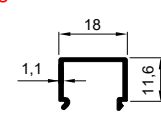
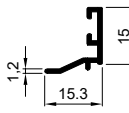
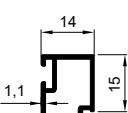
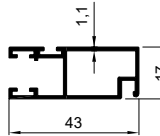
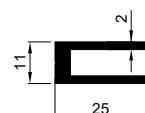
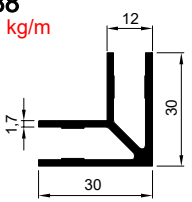
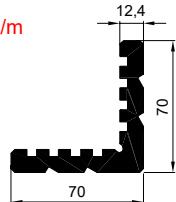
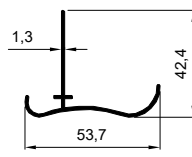
<p>130 0.661 kg/m</p> 	<p>1242 0.779 kg/m</p> 	<p>5329 0.858 kg/m</p> 	<p>12037 0.534 kg/m</p> 
<p>1240 0.285 kg/m</p> 	<p>258 0.518 kg/m</p> 	<p>132 0.618 kg/m</p> 	<p>135 0.261 kg/m</p> 
<p>134 0.302 kg/m</p> 	<p>137 0.160 kg/m</p> 	<p>131 0.166 kg/m</p> 	<p>290 0.140 kg/m</p> 
<p>136 0.131 kg/m</p> 	<p>138 0.173 kg/m</p> 	<p>1243 0.434 kg/m</p> 	<p>141 0.346 kg/m</p> 
<p>188 0.537 kg/m</p> 	<p>413 3.667 kg/m</p> 	<p>1241 0.390 kg/m</p> 	



TS45 TUBA SÜRME (100 mm)

TS45 TUBA SLIDING SERIES (100 mm)

<p>147 1.207 kg/m</p>	<p>150 1.185 kg/m</p>	<p>144 1.275 kg/m</p>	<p>145 0.474 kg/m</p>
<p>149 0.451 kg/m</p>	<p>146 0.272 kg/m</p>	<p>148 0.221 kg/m</p>	<p>166 0.196 kg/m</p>
<p>170 0.259 kg/m</p>	<p>2276 0.609 kg/m</p>	<p>2277 0.145 kg/m</p>	<p>2278 0.362 kg/m</p>
<p>500 1.003 kg/m</p>	<p>506 1.075 kg/m</p>	<p>1086 0.217 kg/m</p>	<p>12037 0.534 kg/m</p>
<p>147 ve 150 nolu profillerin çavuş bağlantısı Corner connection for profiles 147-150</p>	<p>144 nolu profilin çavuş bağlantısı Corner connection for profiles 144</p>		
<p>12038 0.352 kg/m</p>			

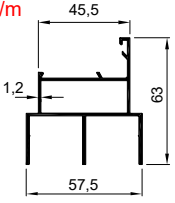
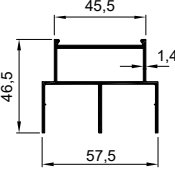
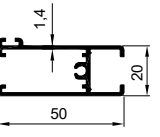
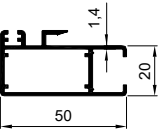
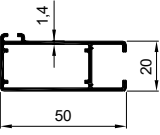
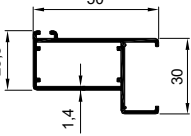
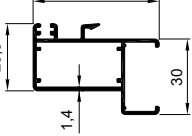
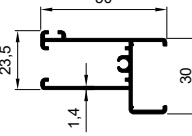
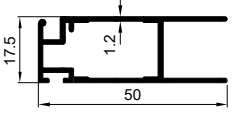
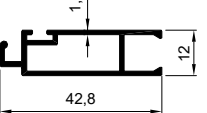
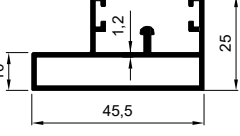
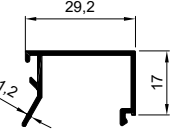
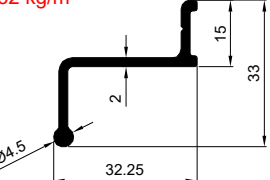
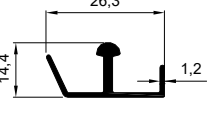
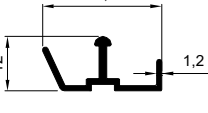

İZMİR SÜRME SERİSİ İZMİR SLIDING SERIES

2120 0.864 kg/m 	2132 0.827 kg/m 	2121 0.584 kg/m 	2122 0.676 kg/m 
2123 0.588 kg/m 	2130 0.617 kg/m 	2129 0.694 kg/m 	2131 0.614 kg/m 
2135 0.493 kg/m 	2136 0.368 kg/m 	2137 0.541 kg/m 	104 0.234 kg/m 
2278 0.362 kg/m 	2124 0.179 kg/m 	2133 0.184 kg/m 	

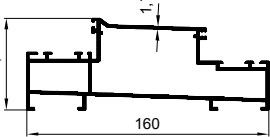
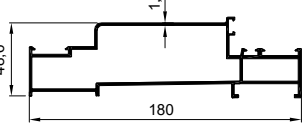
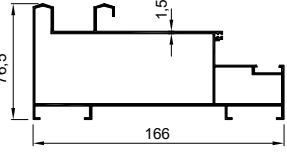
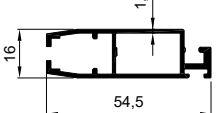
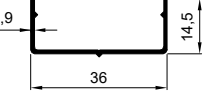
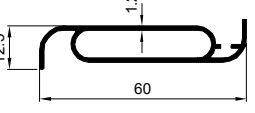
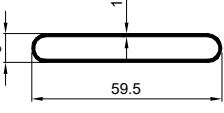

KIBRIS SÜRME SERİSİ KIBRIS SLIDING SERIES

2272 2.480 kg/m 	2275 2.563 kg/m 	2268 2.386 kg/m 	2265 0.540 kg/m 
2266 0.161 kg/m 	2040 0.448 kg/m 	2042 0.342 kg/m 	



S28 SÜRME SERİSİ

S28 SLIDING SERIES

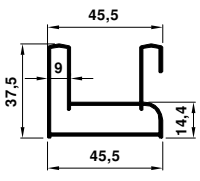
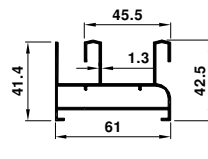
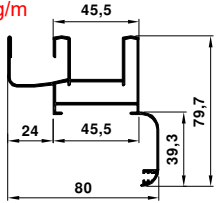
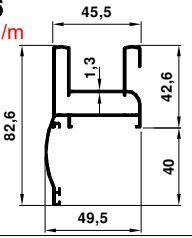
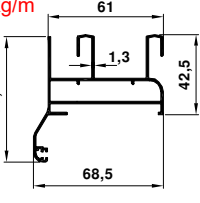
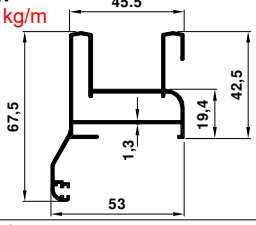
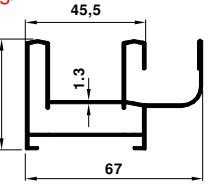
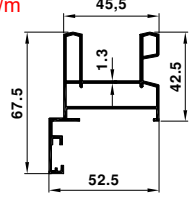
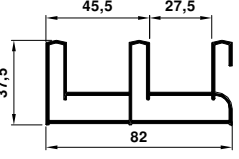
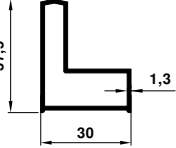
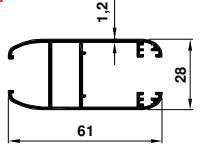
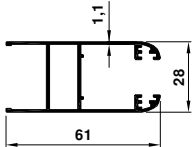
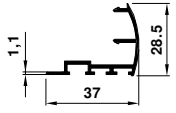
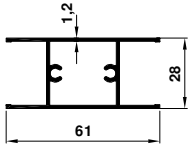
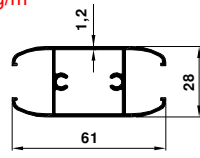
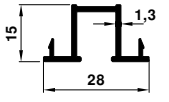
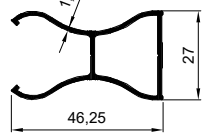
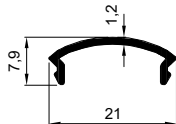
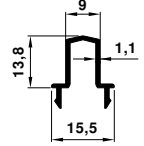
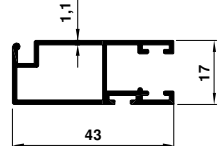
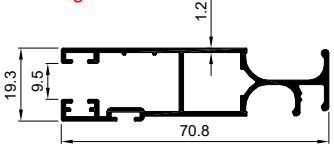
<p>732 0.704 kg/m</p> 	<p>2051 0.946 kg/m</p> 	<p>12210 1.176 kg/m</p> 	<p>6236 0.966 kg/m</p> 
<p>2041 1.105 kg/m</p> 	<p>727 0.927 kg/m</p> 	<p>2940 0.936 kg/m</p> 	<p>2711 1.009 kg/m</p> 
<p>11823 1.209 kg/m</p> 	<p>761 0.480 kg/m</p> 	<p>757 0.703 kg/m</p> 	<p>730 0.644 kg/m</p> 
<p>731 0.291 kg/m</p> 	<p>754 0.664 kg/m</p> 	<p>753 0.707 kg/m</p> 	<p>775 0.229 kg/m</p> 
<p>3594 0.456 kg/m</p> 	<p>3595 0.101 kg/m</p> 	<p>756 0.150 kg/m</p> 	<p>1243 0.434 kg/m</p> 
<p>12339 0.703 kg/m</p> 			



S32 SÜRME SERİSİ

S32 SLIDING SERIES

<p>733 0.927 kg/m</p>	<p>797 1.163 kg/m</p>	<p>726 1.140 kg/m</p>	<p>12209 1.323 kg/m</p>
<p>2637 1.279 kg/m</p>	<p>3076 1.475 kg/m</p>	<p>734 0.770 kg/m</p>	<p>798 0.895 kg/m</p>
<p>8451 0.938 kg/m</p>	<p>765 0.738 kg/m</p>	<p>751 0.381 kg/m</p>	<p>799 0.415 kg/m</p>
<p>776 0.311 kg/m</p>	<p>2073 0.068 kg/m</p>	<p>735 0.279 kg/m</p>	<p>777 0.171 kg/m</p>
<p>736 0.642 kg/m</p>	<p>3594 0.456 kg/m</p>	<p>3595 0.101 kg/m</p>	<p>12339 0.703 kg/m</p>
<p>1243 0.434 kg/m</p>			



CS34 SÜRME SERİSİ CS34 SLIDING SERIES

5590 1.277 kg/m 	3641 1.858 kg/m 	7534 1.441 kg/m 	6570 1.379 kg/m
6571 1.957 kg/m 	3644 0.887 kg/m 	3645 0.377 kg/m 	4038 0.274 kg/m
4039 0.288 kg/m 	12013 0.465 kg/m 	3594 0.456 kg/m 	3595 0.101 kg/m



CS35T SÜRME SERİSİ CS35T SLIDING SERIES

3648 - 3648 1.595 kg/m 	3647 - 3648 2.051 kg/m 	5591 - 5592 1.767 kg/m 	3647-3659-3648 2.950 kg/m
5591-3659-3648 2.790 kg/m 	3650 - 3650 1.412 kg/m 	3651 0.415 kg/m 	5599 0.407 kg/m
5593 - 5594 1.123 kg/m 	3649 0.548 kg/m 	5598 0.302 kg/m 	5596 0.816 kg/m
5595 0.833 kg/m 	5597 0.151 kg/m 	3594 0.456 kg/m 	3595 0.101 kg/m



S35 NOVOLINE SÜRME SERİSİ







S35 NOVOLINE SLIDING SERIES

<p>5822 1.488 kg/m</p> <p>43 85 45 1,3</p>	<p>5823 2.145 kg/m</p> <p>43 130 45 45</p>	<p>11597 1.885 kg/m</p> <p>43 118 45 35,25 1,3</p> <p>9780-9781 ile çalışır. Works with profiles 9780-9781</p>	<p>5824 1.198 kg/m</p> <p>32 90 1,4</p>
<p>5848 1.311 kg/m</p> <p>20 90 1,4</p>	<p>5825 1.331 kg/m</p> <p>20 90 1,6</p>	<p>5833 1.074 kg/m</p> <p>20 75 1,5</p>	<p>5821 0.220 kg/m</p> <p>24,1 29,6</p>
<p>5834 1.378 kg/m</p> <p>20 75 1,5</p>	<p>5831 0.982 kg/m</p> <p>37 77 1,3</p>	<p>5844 0.103 kg/m</p> <p>5,5 11,1</p>	<p>5830 0.614 kg/m</p> <p>37 42 1,3</p>
<p>5850 0.842 kg/m</p> <p>35 56 1,4</p>	<p>5851 0.971 kg/m</p> <p>42,6 83,4 1,3</p>	<p>9780 0.860 kg/m</p> <p>27,7 75 1,2</p>	<p>9781 0.211 kg/m</p> <p>16,35 29,4 1,2</p>
<p>5832 0.436 kg/m</p> <p>21,2 40,9 1,3</p>	<p>5829 0.655 kg/m</p> <p>17 70 1,1</p>	<p>5845 0.141 kg/m</p> <p>4,2 17</p>	<p>598 1.677 kg/m</p> <p>70 70 10,4</p>
<p>12657 0.316 kg/m</p> <p>29 38,5 1,5</p>	<p>3594 0.456 kg/m</p> <p>27 46,25 1,2</p>	<p>3595 0.101 kg/m</p> <p>7,9 21 1,2</p>	<p>12339 0.703 kg/m</p> <p>19,3 70,8 1,2</p>

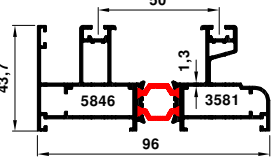
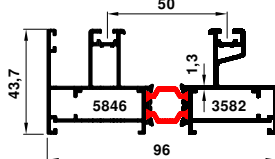
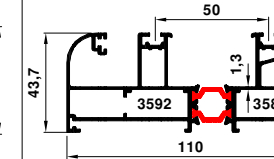
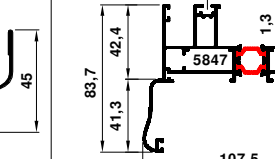
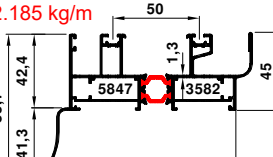
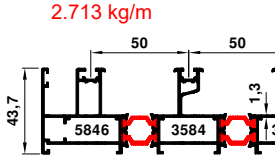
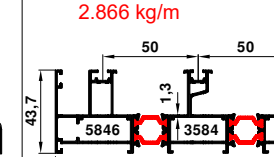
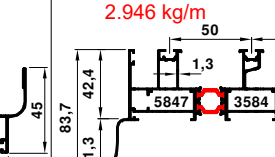
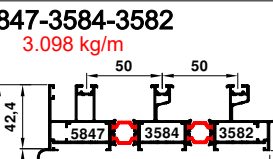
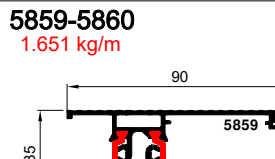

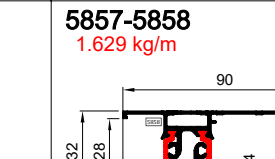
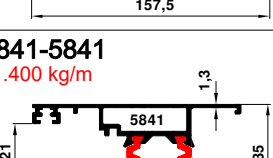
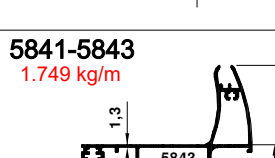
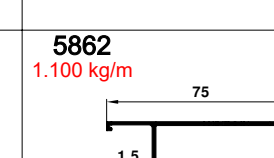
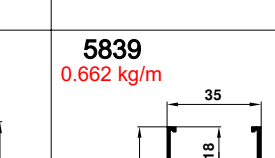
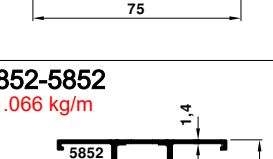
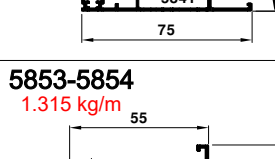
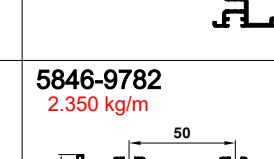
S35 THERMO NOVOLINE SÜRME SERİSİ

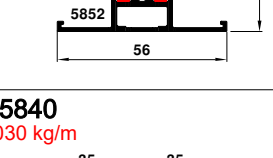
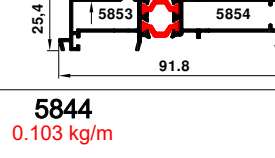
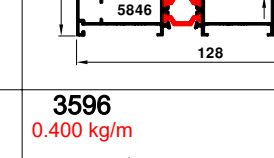
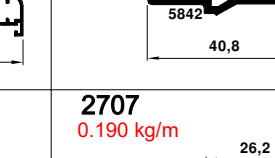
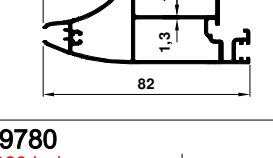
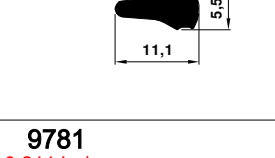
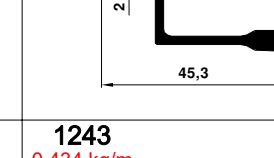
S35 THERMO NOVOLINE SLIDING SERIES

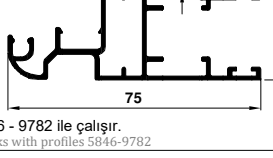
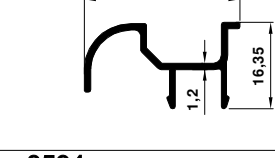
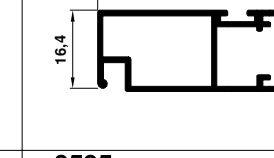
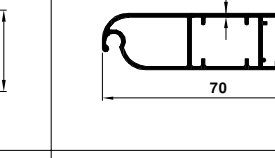
5846-3581 1.799 kg/m 	5846-3582 1.952 kg/m 	3592-3582 2.140 kg/m 	5847-3581 2.031 kg/m 
5847-3582 2.185 kg/m 	5846-3584-3581 2.713 kg/m 	5846-3584-3582 2.866 kg/m 	5847-3584-3581 2.946 kg/m 
5847-3584-3582 3.098 kg/m 	5859-5860 1.651 kg/m 	5855-5856 1.535 kg/m 	5857-5858 1.629 kg/m 
5841-5841 1.400 kg/m 	5841-5843 1.749 kg/m 	5862 1.100 kg/m 	5839 0.662 kg/m 
5852-5852 1.066 kg/m 	5853-5854 1.315 kg/m 	5846-9782 2.350 kg/m 	5842-5842 0.718 kg/m 
5840 1.030 kg/m 	5844 0.103 kg/m 	3596 0.400 kg/m 	2707 0.190 kg/m 
9780 0.860 kg/m 	9781 0.211 kg/m 	1243 0.434 kg/m 	5829 0.655 kg/m 
5845 0.141 kg/m  <small>5846 - 9782 ile çalışır. Works with profiles 5846-9782</small>	3594 0.456 kg/m 	3595 0.101 kg/m 	598 1.677 kg/m 



S35 THERMO NOVOLINE SÜRME SERİSİ

S35 THERMO NOVOLINE SLIDING SERIES

12651-12652
1.810 kg/m

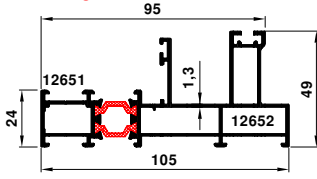

12651-12653
1.974 kg/m

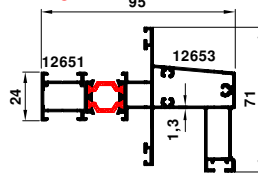

12651-12872
2.203 kg/m

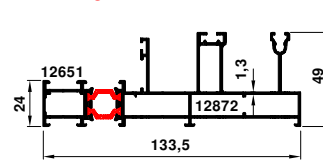

12654
1.623 kg/m

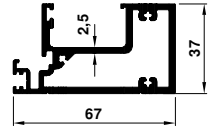

12649
0.666 kg/m

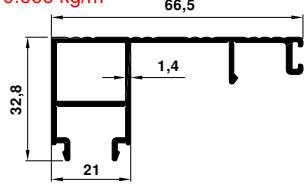

12655
2.435 kg/m

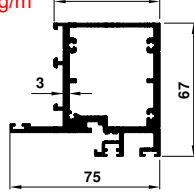

12656
0.351 kg/m

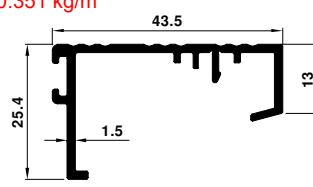



S38 THERMO SÜRME SERİSİ

S38 THERMO SLIDING SERIES

2700-2701
1.649 kg/m

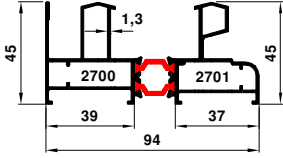

2700-3025
1.812 kg/m

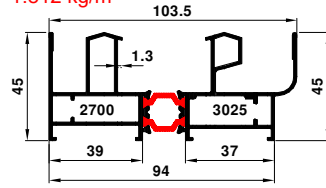

2818-2701
1.847 kg/m

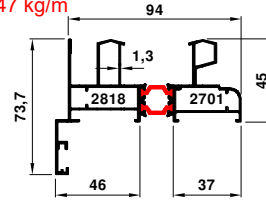

2818-3025
2.016 kg/m

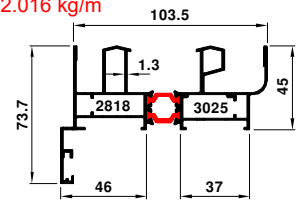

3593-2701
1.948 kg/m

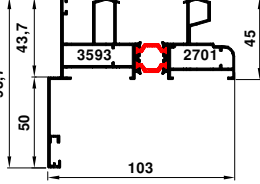

2700-2704-2701
2.523 kg/m

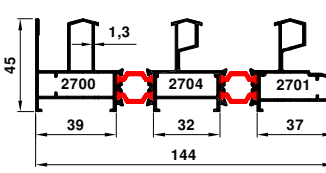

2700-2704-3025
2.700 kg/m

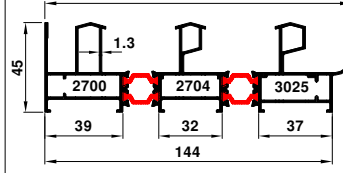

2818-2704-2701
2.721 kg/m

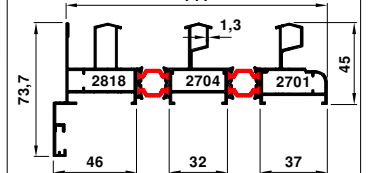

2818-2704-3025
2.898 kg/m

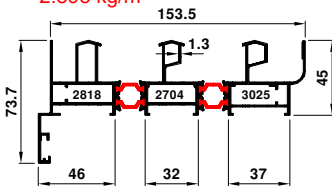

3580-3581
1.749 kg/m

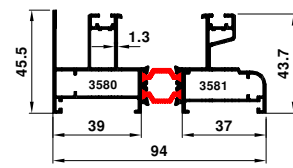

3592-3582
2.128 kg/m

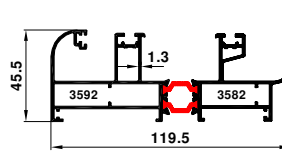

3580-3582
1.902 kg/m

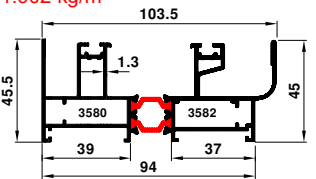

5846-3581
1.799 kg/m

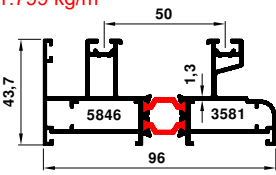

5846-3582
1.952 kg/m

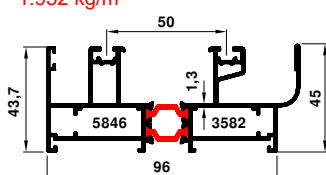

3583-3581
1.981 kg/m

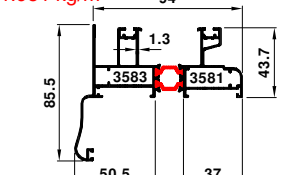

3582-3583
2.134 kg/m

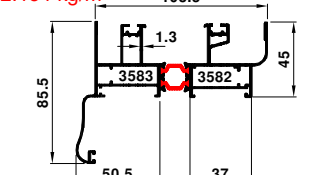

5847-3581
2.026 kg/m

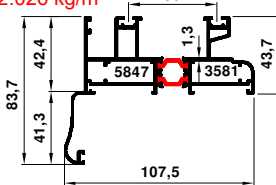

5847-3582
2.185 kg/m

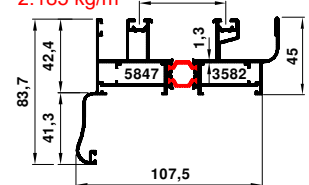

5846-3584-3582
2.866 kg/m

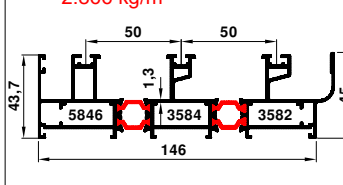

5847-3584-3581
2.946 kg/m

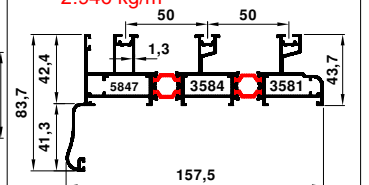

5847-3584-3582
3.098 kg/m

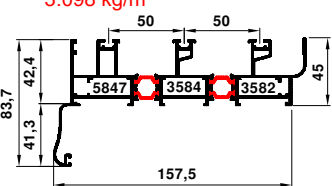

3580-3584-3581
2.662 kg/m

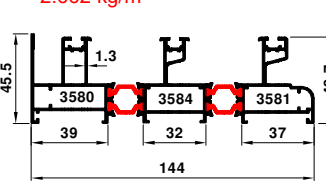

3580-3584-3582
2.815 kg/m

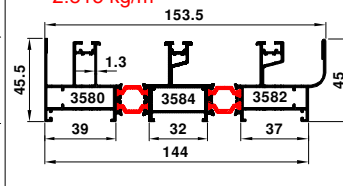

3583-3584-3581
2.894 kg/m

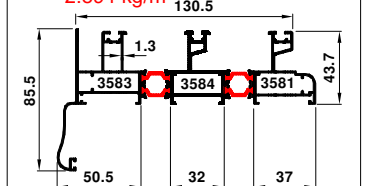

3583-3584-3582
3.047 kg/m

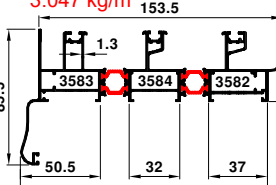

5846-3584-3581
2.713 kg/m

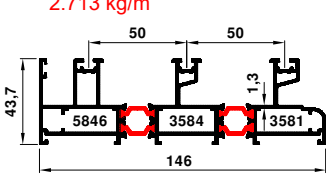

2705-2705
1.485 kg/m

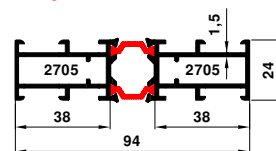

3588-3588
1.134 kg/m

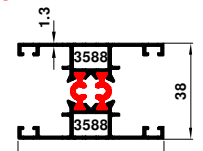

3585-3586
1.289 kg/m

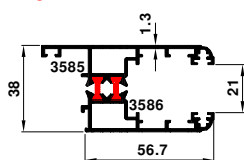

3587
0.140 kg/m

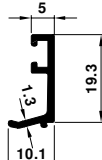

3586 nolu profilele çalışır.
Works with profiles 3586

3598
0.263 kg/m

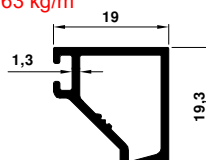

3586 nolu profilele çalışır.
Works with profiles 3586

2703
0.403 kg/m

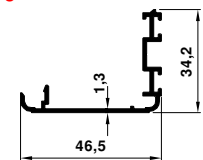



S38 THERMO SÜRME SERİSİ

S38 THERMO SLIDING SERIES

1932-1933
1.478 kg/m

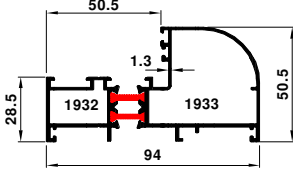

3590-3590
0.454 kg/m

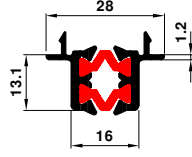

2702-2811
1.438 kg/m

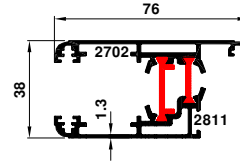

2702-2702
1.538 kg/m

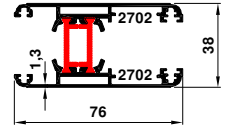

1684
0.325 kg/m

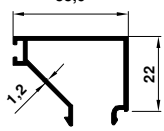

3588-3589
0.942 kg/m

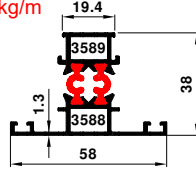

3586 nolu profilele çalışır.
Works with profiles 3586

2812-2813
0.883 kg/m

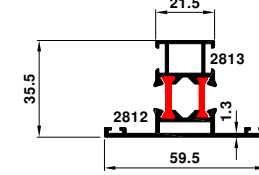

2798-2798
1.021 kg/m

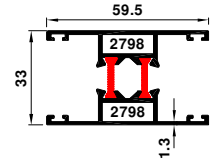

3594
0.456 kg/m

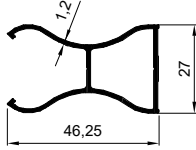

3595
0.101 kg/m

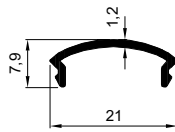

2189
0.180 kg/m

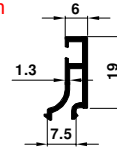

2811 nolu profilele çalışır.
Works with profiles 2811

2814
0.151 kg/m

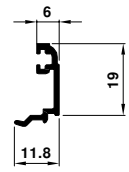

2811 nolu profilele çalışır.
Works with profiles 2811

2707
0.190 kg/m

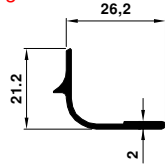

3591
0.112 kg/m

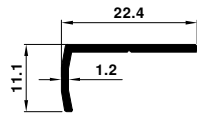

3596
0.400 kg/m

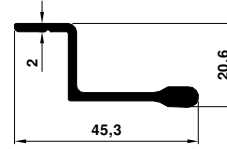

8267
0.086 kg/m

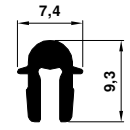

6877
0.061 kg/m

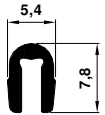

598
1.677 kg/m

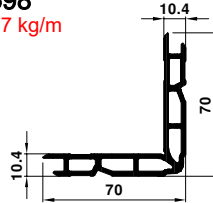

1662
2.576 kg/m

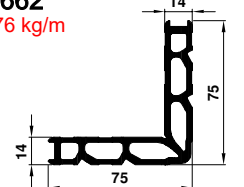

1932, 1933 ve 3585-3586 profiller ile çalışır.
Works with profiles 1932, 1933 and 3585-3586

296
1.043 kg/m

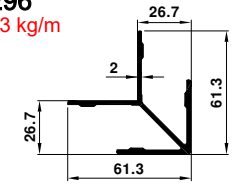

2706 nolu profilin çavuş bağlantısı
Corner connection for profiles 2706

1243
0.434 kg/m

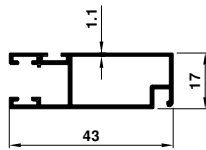

2819
0.093 kg/m

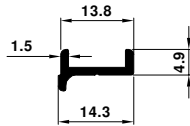

12339
0.703 kg/m

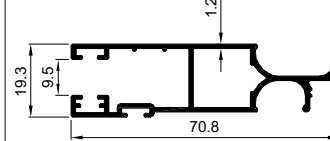



HS55 THERMO SÜRME SERİSİ

HS55 THERMO SLIDING SERIES

12052-6001 2.776 kg/m 	6000-6001 2.598 kg/m 	6002-6003 3.044 kg/m 	6008-6009 2.082 kg/m
6000 - 6024 - 6001 4.046 kg/m 	6010-6011 2.222 kg/m 	11524 0.681 kg/m 	4112 0.078 kg/m
6004-6005 1.845 kg/m 	6006 0.510 kg/m 	6012-6013 2.127 kg/m 	55-1718-8007 2.786 kg/m
55-1700-1716 1.377 kg/m 	55-1702-1761 1.560 kg/m 	55-1704-1717 1.615 kg/m 	55-1706-1718 1.877 kg/m
6022 0.688 kg/m 	6014-6015 0.866 kg/m 	6020 0.461 kg/m 	6021 0.570 kg/m
6017 0.327 kg/m 	4242 0.094 kg/m 	6019 0.148 kg/m 	1773 0.985 kg/m
1774 0.365 kg/m 	3594 0.456 kg/m 	3595 0.101 kg/m 	1662 2.576 kg/m
1663 3.526 kg/m 	1948 0.225 kg/m 	1698 0.253 kg/m 	3539 0.277 kg/m



HS55 THERMO SÜRME SERİSİ

HS55 THERMO SLIDING SERIES

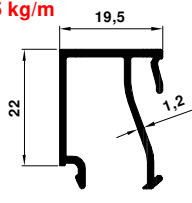
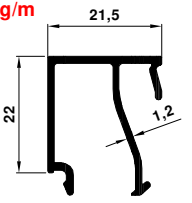
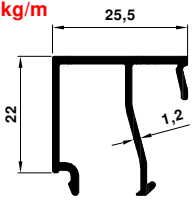
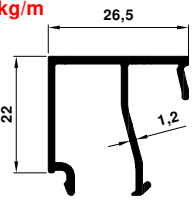
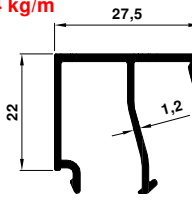
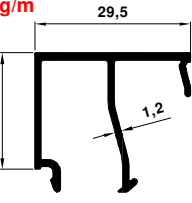
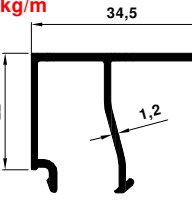
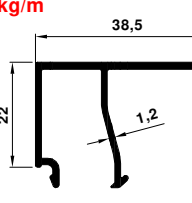
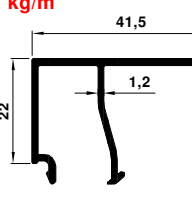
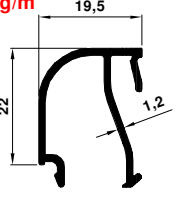
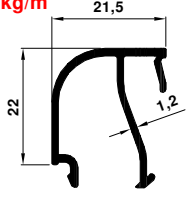
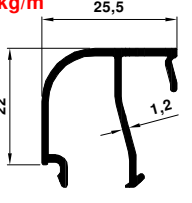
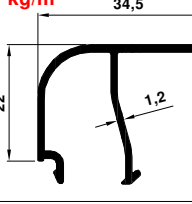
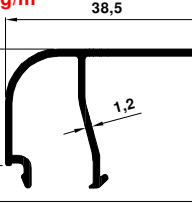
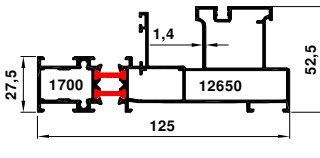
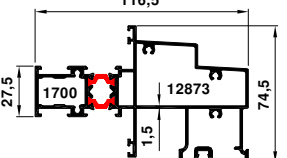
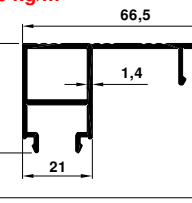
<p>1699 0.285 kg/m</p> 	<p>1745 0.292 kg/m</p> 	<p>1949 0.306 kg/m</p> 	<p>2236 0.310 kg/m</p> 
<p>1966 0.314 kg/m</p> 	<p>3636 0.321 kg/m</p> 	<p>1747 0.340 kg/m</p> 	<p>1749 0.356 kg/m</p> 
<p>3537 0.367 kg/m</p> 	<p>5546 0.271 kg/m</p> 	<p>1746 0.279 kg/m</p> 	<p>5527 0.293 kg/m</p> 
<p>1748 0.327 kg/m</p> 	<p>1750 0.342 kg/m</p> 	<p>1700-12650 2.367 kg/m</p> 	<p>1700-12873 2.766 kg/m</p> 
<p>12649 0.666 kg/m</p> 			



WD37 SERISI

WD37 SERIES

3915 0.572 kg/m 	766 0.632 kg/m 	707 0.649 kg/m 	794 0.700 kg/m
596 0.719 kg/m 	708 0.812 kg/m 	13124 0.678 kg/m 	13123 0.236 kg/m
762 0.833 kg/m 	6237 0.875 kg/m 	763 1.021 kg/m 	709 1.045 kg/m
773 0.728 kg/m 	710 0.757 kg/m 	768 0.933 kg/m 	795 0.933 kg/m
691 0.977 kg/m 	692 0.977 kg/m 	599 0.997 kg/m 	600 0.997 kg/m
769 0.752 kg/m 	713 0.809 kg/m 	767 0.945 kg/m 	714 1.057 kg/m
715 1.532 kg/m 	752 1.413 kg/m 	760 0.724 kg/m 	759 0.307 kg/m
764 0.385 kg/m 	2240 0.499 kg/m 	758 0.460 kg/m 	785 1.017 kg/m

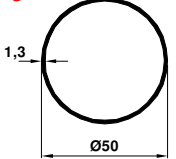
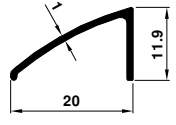
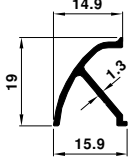
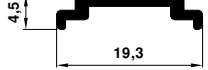
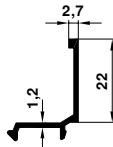
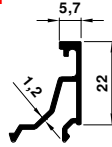
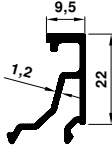
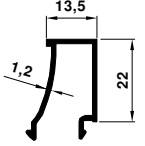
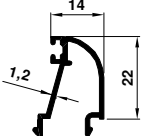
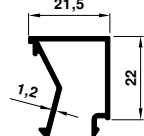
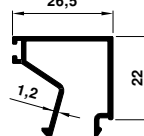
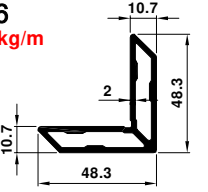
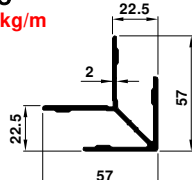
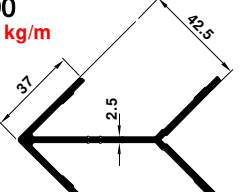
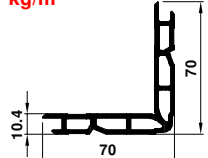
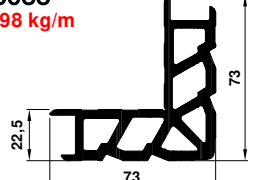
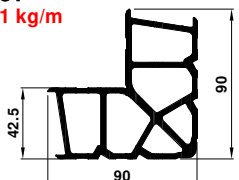
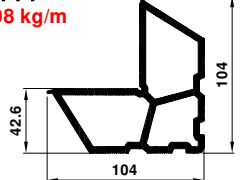

WD37 SERİSİ WD37 SERIES

755 0.541 kg/m 	4242 0.094 kg/m 	7021 0.140 kg/m 	8241 0.099 kg/m 
771 0.165 kg/m 	772 0.225 kg/m 	12699 0.243 kg/m 	793 0.235 kg/m 
791 0.246 kg/m 	770 0.270 kg/m 	792 0.301 kg/m 	386 1.088 kg/m 
388 1.012 kg/m 	390 1.381 kg/m 	598 1.677 kg/m 	3088 3.498 kg/m 
644,646,763 ve 794 nolu profillerin çavuş bağlantısı Corner connection for profiles 644,646,763 and 794	691 ve 692 nolu profillerin çavuş bağlantısı Corner connection for profiles 691 and 692	707 nolu profilin köşe takozu Corner connection for profiles 707	643,649,766 ve 773 nolu profillerin çavuş bağlantısı Corner connection for profiles 643,649,776,773
597 4.241 kg/m 	4777 4.598 kg/m 		
691 ve 692 nolu profillerin köşe takozu Corner connection for profiles 691 and 692	691 ve 692 nolu profillerin köşe takozu Corner connection for profiles 691 and 692		



WD45 SERISI



WD45 SERIES

746 0.672 kg/m 	788 0.838 kg/m 	796 0.964 kg/m 	725 0.935 kg/m
11615 0.912 kg/m 	778 0.990 kg/m 	782 1.149 kg/m 	620 1.148 kg/m
747 0.799 kg/m 	779 0.952 kg/m 	780 1.100 kg/m 	686 1.186 kg/m
748 1.093 kg/m 	787 1.022 kg/m 	790 1.020 kg/m 	737 1.089 kg/m
631 1.497 kg/m 	738 1.089 kg/m 	635 1.081 kg/m 	609 1.239 kg/m
622 1.220 kg/m 	774 1.144 kg/m 	781 1.387 kg/m 	5923 1.157 kg/m
745 0.881 kg/m 	749 1.018 kg/m 	621 1.094 kg/m 	608 1.338 kg/m
750 1.740 kg/m 	610 0.885 kg/m 	783 0.872 kg/m 	739 0.821 kg/m

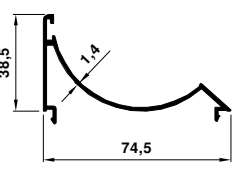
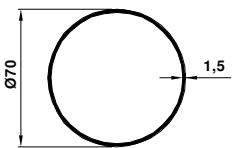

WD45 SERISI

WD45 SERIES

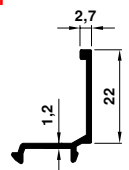
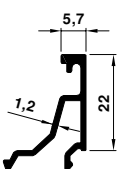
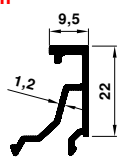
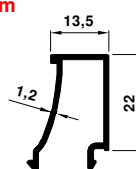
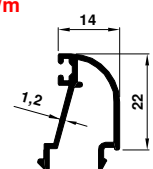
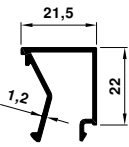
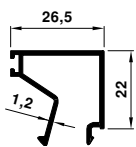
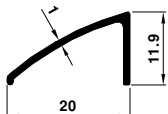
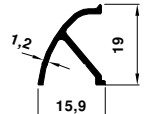
<p>784 0.581 kg/m</p> 	<p>786 0.875 kg/m</p> 	<p>8241 0.099 kg/m</p> 	<p>771 0.165 kg/m</p> 
<p>772 0.225 kg/m</p> 	<p>12699 0.243 kg/m</p> 	<p>793 0.235 kg/m</p> 	<p>791 0.246 kg/m</p> 
<p>770 0.270 kg/m</p> 	<p>792 0.301 kg/m</p> 	<p>4242 0.094 kg/m</p> 	<p>7021 0.140 kg/m</p> 



WD50 THERMO SERİSİ

WD50 THERMO SERIES

641-642 1.035 kg/m 	13157-13158 1.059 kg/m 	13160-13161 1.247 kg/m 	13159-13160 1.413 kg/m
638-645 1.319 kg/m 	643-644 1.209 kg/m 	641-645 1.123 kg/m 	643-646 1.295 kg/m
638-642 1.232 kg/m 	649-650 1.336 kg/m 	647-648 1.183 kg/m 	601-602 1.389 kg/m
677-678 1.711 kg/m 	651-652 1.833 kg/m 	605-685 1.738 kg/m 	684-685 1.746 kg/m
655-656 1.162 kg/m 	657-603 1.479 kg/m 	657-658 1.388 kg/m 	659-660 2.333 kg/m
659-604 2.418 kg/m 	604-661 2.514 kg/m 	660-661 2.429 kg/m 	662-663 1.177 kg/m
711-682 1.211 kg/m 	681-682 1.084 kg/m 	1734-1735 1.466 kg/m 	712 0.245 kg/m
637 0.181 kg/m 	676 0.331 kg/m 	664 0.266 kg/m 	665 0.253 kg/m



WD50 THERMO SERİSİ

WD50 THERMO SERIES

<p>389 1.338 kg/m</p> <p>605,677,678,684 nolu profillerin çavuş bağlantısı Corner connection for profiles 605,677,678,684</p>	<p>388 1.012 kg/m</p> <p>644,646 nolu profillerin çavuş bağlantısı Corner connection for profiles 644 and 646</p>	<p>4242 0.094 kg/m</p> <p></p>	<p>7021 0.140 kg/m</p> <p></p>
<p>8241 0.099 kg/m</p> <p></p>	<p>479 0.364 kg/m</p> <p></p>	<p>12375 0.326 kg/m</p> <p></p>	



WD55 SERİSİ

WD55 SERIES

1780 1.135 kg/m 	1685 0.902 kg/m 	1781 1.269 kg/m 	1782 1.347 kg/m
1905 0.831 kg/m 	1906 1.033 kg/m 	1907 0.934 kg/m 	11959 1.065 kg/m
1908 1.282 kg/m 	1909 0.993 kg/m 	3540 1.196 kg/m 	1910 1.374 kg/m
1686 1.004 kg/m 	1687 1.064 kg/m 	5580 1.110 kg/m 	12229 1.228 kg/m
12747 1.462 kg/m 	11822 0.981 kg/m 	1693 1.001 kg/m 	1790 1.225 kg/m
5156 1.314 kg/m 	1694 1.103 kg/m 	11960 1.248 kg/m 	3541 1.394 kg/m
1783 1.489 kg/m 	1901 1.499 kg/m 	5520 1.684 kg/m 	4687 1.648 kg/m
1788 1.966 kg/m 	2096 2.321 kg/m 	1784 1.180 kg/m 	1691 0.933 kg/m



WD55 SERİSİ

WD55 SERIES

1785 1.467 kg/m 	12059 1.242 kg/m 	1692 1.039 kg/m 	3545 1.052 kg/m
5158 1.206 kg/m 	1786 1.820 kg/m 	3943 1.559 kg/m 	5157 1.206 kg/m
1787 1.772 kg/m 	1660 1.516 kg/m 	1900 1.497 kg/m 	5519 1.614 kg/m
1902 2.114 kg/m 	1789 2.588 kg/m 	4356-4357 0.930 kg/m 	1793 0.950 kg/m
1792 0.829 kg/m 	1791 1.082 kg/m 	11925 1.065 kg/m 	6569 0.419 kg/m
1794 0.461 kg/m 	1779 0.439 kg/m 	1913 0.621 kg/m 	1795 0.638 kg/m
9664 0.399 kg/m 	1681 0.340 kg/m 	1912 0.211 kg/m 	4251 0.182 kg/m
1911 0.426 kg/m 	1904 1.337 kg/m 	8241 0.099 kg/m 	1755 0.234 kg/m

1783 ve 1785 için Çavuş Bağlantı
Corner connection for profiles 1783 and 1785

1685,1686,1687,1780,1781 ve 1782 nolu profiller ile çalışır.
Works with profiles 1685-1686-1687-1780-1781 and 1782



WD55 SERİSİ

WD55 SERIES

1011 0.402 kg/m 	4242 0.094 kg/m 	7021 0.140 kg/m 	12375 0.326 kg/m
10923 0.295 kg/m 	1722 0.623 kg/m <small>1704,1706,1717,1718,1783 ve 2096 nolu profiller ile çalışır. Works with profiles 1704-1706-1717-1718-1783 and 2096.</small>	12371 0.469 kg/m 	1775 1.525 kg/m
2052 1.724 kg/m 	1764 0.312 kg/m 	1948 0.225 kg/m 	1698 0.253 kg/m
3539 0.277 kg/m 	1699 0.285 kg/m 	1745 0.292 kg/m 	1949 0.306 kg/m
2236 0.310 kg/m 	1966 0.314 kg/m 	3636 0.321 kg/m 	3536 0.329 kg/m
1747 0.340 kg/m 	1749 0.356 kg/m 	3537 0.367 kg/m 	5546 0.271 kg/m
1746 0.279 kg/m 	5527 0.293 kg/m 	1748 0.327 kg/m 	1750 0.342 kg/m
1662 2.576 kg/m 	1695 2.540 kg/m 	1661 3.629 kg/m 	1663 3.526 kg/m

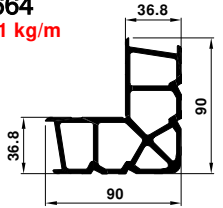
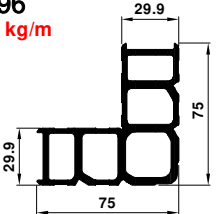
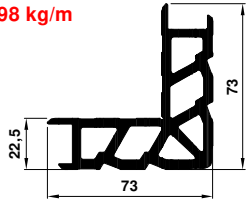
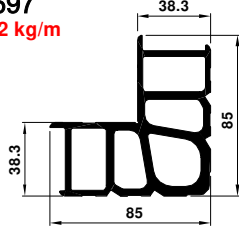
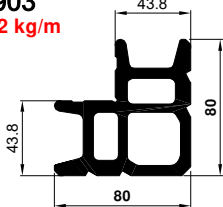
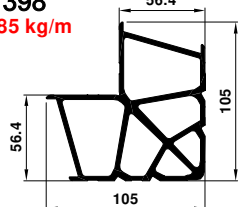

WD55 SERİSİ
WD55 SERIES

<p>1664 3.991 kg/m</p> 	<p>1696 3.340 kg/m</p> 	<p>3088 3.498 kg/m</p> 	<p>1697 4.212 kg/m</p> 
<p>1903 6.162 kg/m</p> 	<p>1398 5.085 kg/m</p> 		



WD55 THERMO SERİSİ

WD55 THERMO SERIES

(15 mm'lik ısı yalıtım fişli kullanılır)
(15 mm Thermal Break)

<p>55-1700-1701 1.353 kg/m</p>	<p>55-1702-1703 1.534 kg/m</p>	<p>55-1704-1705 1.593 kg/m</p>	<p>55-1706-1707 1.856 kg/m</p>
<p>55-5551-5554 1.366 kg/m</p>	<p>55-5553-5555 1.657 kg/m</p>	<p>55-1700-1768 1.271 kg/m</p>	<p>55-1702-1770 1.426 kg/m</p>
<p>55-1936-1937 1.195 kg/m</p>	<p>55-1974-1975 1.328 kg/m</p>	<p>55-5550-5551 1.240 kg/m</p>	<p>55-12807-6500 1.455 kg/m</p>
<p>55-5552-5553 1.494 kg/m</p>	<p>55-1706-1771 1.748 kg/m</p>	<p>55-1704-1769 1.510 kg/m</p>	<p>55-1972-1973 1.411 kg/m</p>
<p>55-3548-3549 1.661 kg/m</p>	<p>55-1932-1933 1.478 kg/m</p>	<p>55-1771-2288 2.057 kg/m</p>	<p>55-1707-2288 2.165 kg/m</p>
<p>55-7110-7111 1.754 kg/m</p>	<p>55-1769-5393 1.660 kg/m</p>	<p>55-1705-5393 1.741 kg/m</p>	<p>55-5152-5153 1.564 kg/m</p>
<p>55-5159-5153 1.714 kg/m</p>	<p>55-5130-5131 1.619 kg/m</p>	<p>55-2820-5551 1.484 kg/m</p>	<p>55-3550-3551 1.222 kg/m</p>
<p>55-5556-5557 1.360 kg/m</p>	<p>55-3558-3559 1.320 kg/m</p>	<p>55-1708-1709 1.359 kg/m</p>	<p>55-3562-3563 1.451 kg/m</p>



WD55 THERMO SERİSİ

WD55 THERMO SERIES

(15 mm'lik ısı yalıtım fişli kullanılır)
(15 mm Thermal Break)

<p>55-6502-6503 1.496 kg/m</p>	<p>55-3560-3561 1.480 kg/m</p>	<p>55-1710-1711 1.583 kg/m</p>	<p>55-1712-1713 1.603 kg/m</p>
<p>55-1642-1643 1.550 kg/m</p>	<p>55-3564-3565 1.545 kg/m</p>	<p>55-6504-6505 1.637 kg/m</p>	<p>55-5558-5559 1.660 kg/m</p>
<p>55-3944-3945 1.760 kg/m</p>	<p>55-3566-3567 1.767 kg/m</p>	<p>55-1714-1715 1.898 kg/m</p>	<p>55-5569-5573 1.450 kg/m</p>
<p>55-5571-5572 1.430 kg/m</p>	<p>55-5569-5570 1.643 kg/m</p>	<p>55-5568-5569 1.647 kg/m</p>	<p>55-8442-8443 2.169 kg/m</p>
<p>55-5588-5589 1.740 kg/m</p>	<p>55-5525-5526 2.131 kg/m</p>	<p>55-5574-5575 2.055 kg/m</p>	<p>55-5150-5151 1.641 kg/m</p>
<p>55-12097-12098 1.888 kg/m</p>	<p>55-5160-5161 2.020 kg/m</p>	<p>55-5585-5586 2.032 kg/m</p>	<p>55-4303-4304 2.080 kg/m</p>
<p>55-3568-3569 2.095 kg/m</p>	<p>55-1724-1725 2.515 kg/m</p>	<p>55-3570-3571 2.357 kg/m</p>	<p>55-4359-4360 2.142 kg/m</p>
<p>55-5576-5577 2.077 kg/m</p>	<p>55-3574-3575 2.406 kg/m</p>	<p>55-1950-1951 2.605 kg/m</p>	<p>55-5162-5163 2.505 kg/m</p>



WD55 THERMO SERİSİ

WD55 THERMO SERIES

(15 mm'lik ısı yalıtım fişili kullanılır)
(15 mm Thermal Break)

55-1700-1716

1.387 kg/m

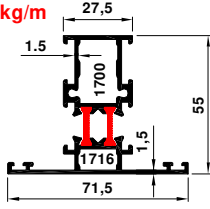

55-1702-1761

1.570 kg/m

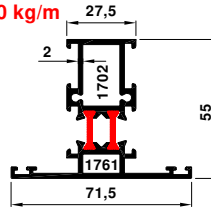

55-3576-3577

1.286 kg/m

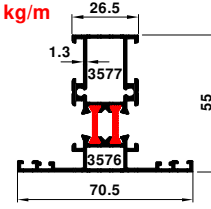

55-3578-3579

1.518 kg/m

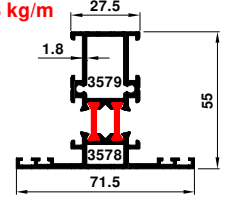

55-1640-1641

1.735 kg/m

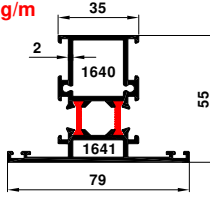

55-1706-1718

1.888 kg/m

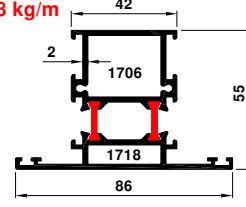

55-5564-5565

1.411 kg/m

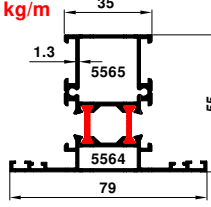

55-6500-6501

1.644 kg/m

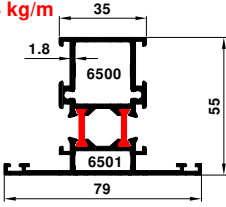

55-5566-5567

1.663 kg/m

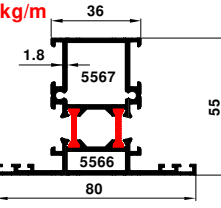

55-3637-3638

1.506 kg/m

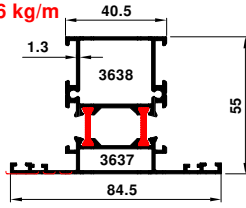

55-3639-3640

1.782 kg/m

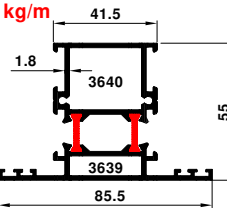

55-1704-1717

1.625 kg/m

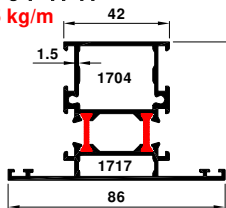

55-1650-1651

1.821 kg/m

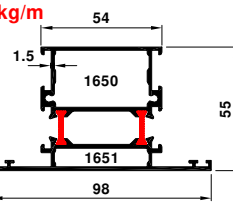

55-5521-5522

2.272 kg/m

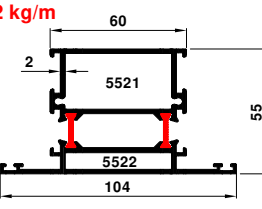

55-4300-4301

2.041 kg/m

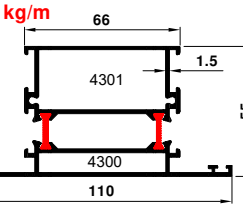

55-1719-1720

2.839 kg/m

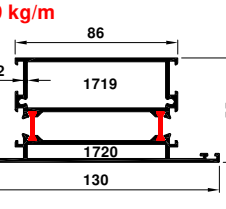

55-4300-4302

2.151 kg/m

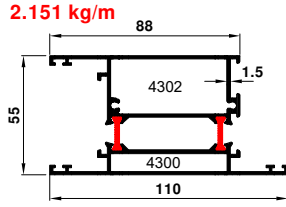

55-5154-5155

2.370 kg/m

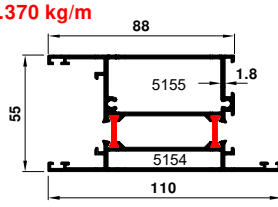

55-1720-1721

2.977 kg/m

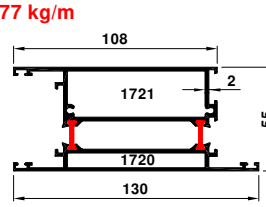

55-5523-5524

3.952 kg/m

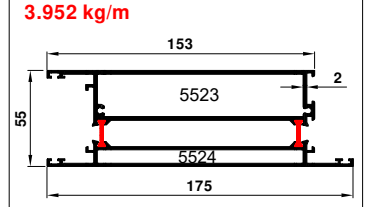

55-9788-9789

4.386 kg/m

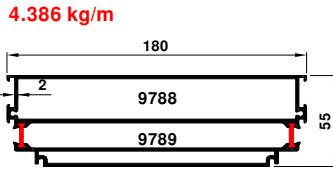

55-3640-3542

2.376 kg/m

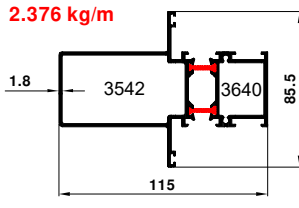

55-1718-8007

2.786 kg/m

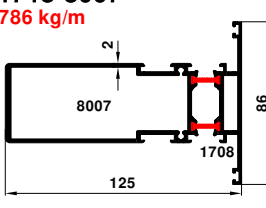

55-11923-1727

1.289 kg/m

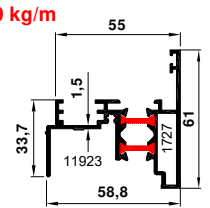

55-11924-5579

1.184 kg/m

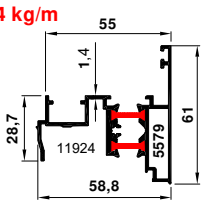

55-1762-1763

1.190 kg/m

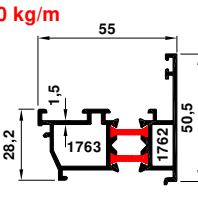

55-1734-1735

1.465 kg/m

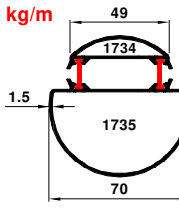

55-1952-1953

1.397 kg/m

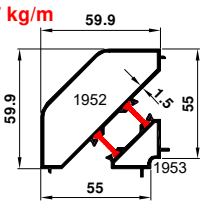

55-1728-1729

1.337 kg/m

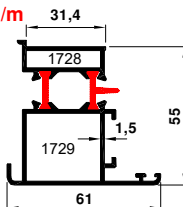

1911

0.425 kg/m

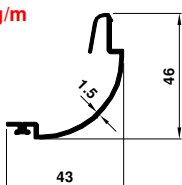

1912

0.211 kg/m

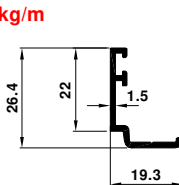

1681

0.340 kg/m

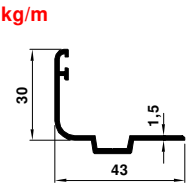



WD55 THERMO SERİSİ

WD55 THERMO SERIES

(15 mm'lik ısı yalıtım fişli kullanılır)
(15 mm Thermal Break)

55-4356-4357 0.930 kg/m 	1011 0.402 kg/m 	7021 0.140 kg/m 	4242 0.094 kg/m
4358 0.316 kg/m 	12375 0.326 kg/m 	10923 0.295 kg/m 	8241 0.099 kg/m
1773 0.985 kg/m 	1774 0.365 kg/m 	1722 0.623 kg/m 	1755 0.234 kg/m
9692 0.240 kg/m 	11416 0.135 kg/m 	1764 0.312 kg/m 	2052 1.724 kg/m
1661 3.629 kg/m 	1662 2.576 kg/m 	1695 2.540 kg/m 	3546 3.357 kg/m
1696 3.340 kg/m 	7022 3.952 kg/m 	3698 4.604 kg/m 	1663 3.526 kg/m
7040 3.998 kg/m 	1664 3.991 kg/m 	597 4.241 kg/m 	3547 4.884 kg/m
1398 5.089 kg/m 	1760 8.436 kg/m 	1736 0.210 kg/m 	1948 0.225 kg/m



WD55 THERMO SERİSİ

WD55 THERMO SERIES

(15 mm'lik ısı yalıtım fişli kullanılır)
(15 mm Thermal Break)

1698 0.253 kg/m 	3539 0.277 kg/m 	1699 0.285 kg/m 	1745 0.292 kg/m
1949 0.306 kg/m 	2236 0.310 kg/m 	1966 0.314 kg/m 	3636 0.321 kg/m
3536 0.329 kg/m 	1747 0.340 kg/m 	1749 0.356 kg/m 	3537 0.367 kg/m
5546 0.271 kg/m 	1746 0.279 kg/m 	5527 0.293 kg/m 	1748 0.327 kg/m
1750 0.342 kg/m 			



HEMYÜZ SİSTEM (Birlikte çalışırlar ,Orta kayıt ve Etek Profilleri Kanat Profili içerisinde ek olarak kullanılabilir.)
SYMMETRICAL SYSTEM (These profiles work together. Mullion and End profiles can be used with in sash profiles.)

55-1737-1738 1.661 kg/m 	55-1739-1740 1.672 kg/m 	55-1741-1742 2.355 kg/m 	55-1743-1744 2.351 kg/m
55-1730-1731 1.026 kg/m 	55-1732-1733 1.027 kg/m 		

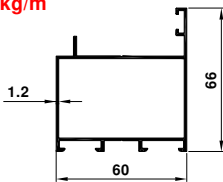
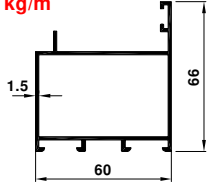
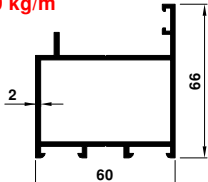
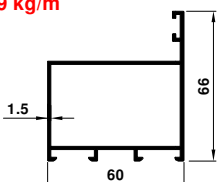
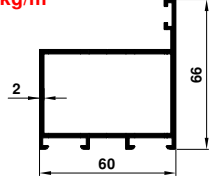
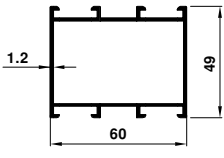
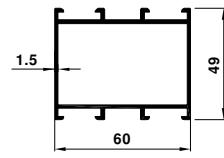
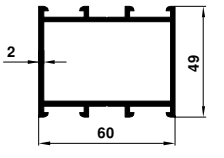
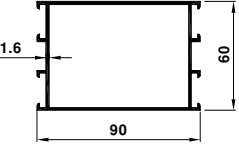
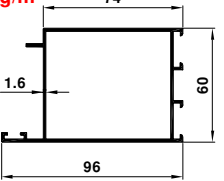

WD60 SERİSİ

WD60 SERIES

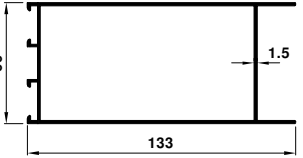
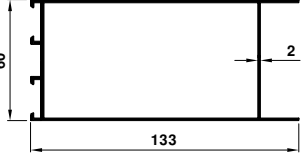
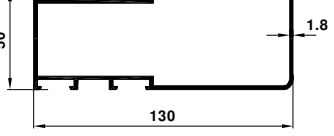
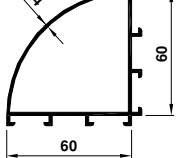
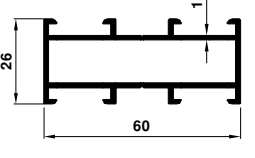
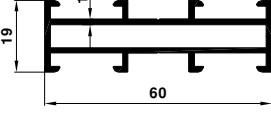
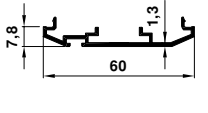
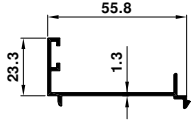
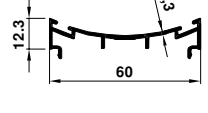
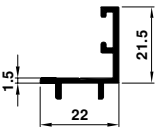
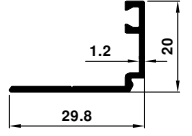
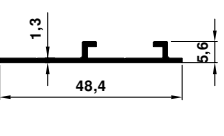
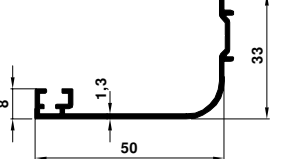
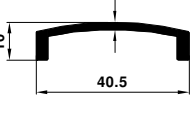
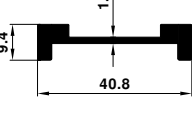
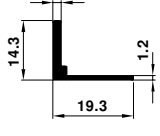
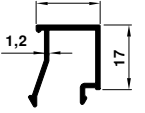
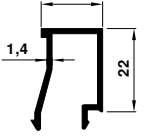
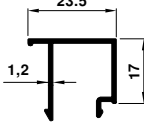
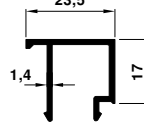
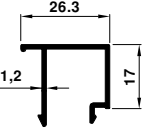
6080 0.888 kg/m 	451 1.064 kg/m 	2020 1.339 kg/m 	522 1.029 kg/m 
521 1.290 kg/m 	569 0.861 kg/m 	452 1.013 kg/m 	2021 1.264 kg/m 
457 1.419 kg/m 	475 1.381 kg/m 	7396 1.435 kg/m 	518 1.621 kg/m 
456 2.112 kg/m 	705 1.914 kg/m 	453 1.059 kg/m 	530 0.826 kg/m 
478 0.770 kg/m 	700 0.370 kg/m 	701 0.380 kg/m 	704 0.410 kg/m 
2030 0.247 kg/m 	481 0.183 kg/m 	480 0.218 kg/m 	479 0.364 kg/m 
5673 0.323 kg/m 	5674 0.433 kg/m 	5675 0.142 kg/m 	455 0.207 kg/m 
2023 0.277 kg/m 	454 0.228 kg/m 	2022 0.262 kg/m 	2279 0.236 kg/m 



WD60 SERİSİ

WD60 SERIES

<p>509 0.277 kg/m</p>	<p>2273 0.336 kg/m</p>	<p>5786 0.363 kg/m</p>	<p>2281 0.363 kg/m</p>
<p>6975 0.203 kg/m</p>	<p>5601 0.216 kg/m</p>	<p>510 0.255 kg/m</p>	<p>4242 0.094 kg/m</p>
<p>458 1.508 kg/m</p>	<p>410 6.094 kg/m</p>	<p>508 1.112 kg/m</p>	<p>451,452,569 ve 705 no'lu profillerin çavuş bağlantısı Corner connection for profiles 451,452,569 and 705</p>



WD64 THERMO SERİSİ

WD64 THERMO SERIES

(24 mm'lik ısı yalıtım fitili kullanılır)
(24 mm Thermal Break)

64-1700-1701 1.423 kg/m 	64-1702-1703 1.604 kg/m 	64-1704-1705 1.663 kg/m 	64-1706-1707 1.926 kg/m
64-5551-5554 1.436 kg/m 	64-5553-5555 1.727 kg/m 	64-1700-1768 1.341 kg/m 	64-1702-1770 1.496 kg/m
64-1936-1937 1.263 kg/m 	64-1974-1975 1.413 kg/m 	64-5550-5551 1.310 kg/m 	55-12807-6500 1.531 kg/m
64-5552-5553 1.539 kg/m 	64-1706-1771 1.818 kg/m 	64-1704-1769 1.580 kg/m 	64-1972-1973 1.543 kg/m
64-3548-3549 1.731 kg/m 	64-1932-1933 1.548 kg/m 	64-1771-2288 2.127 kg/m 	64-1707-2288 2.235 kg/m
64-7110-7111 1.824 kg/m 	64-1769-5393 1.730 kg/m 	64-1705-5393 1.811 kg/m 	64-5152-5153 1.634 kg/m
64-5159-5153 1.784 kg/m 	64-5130-5131 1.689 kg/m 	64-2820-5551 1.554 kg/m 	64-3550-3551 1.290 kg/m
64-5556-5557 1.423 kg/m 	64-3558-3559 1.375 kg/m 	64-1708-1709 1.422 kg/m 	64-3562-3563 1.514 kg/m



WD64 THERMO SERİSİ

WD64 THERMO SERIES

(24 mm'lik ısı yalıtım fitili kullanılır)
(24 mm Thermal Break)

64-6502-6503 1.572 kg/m 	64-3560-3561 1.550 kg/m 	64-1710-1711 1.646 kg/m 	64-1712-1713 1.666 kg/m
64-1642-1643 1.613 kg/m 	64-3564-3565 1.608 kg/m 	64-6504-6505 1.700 kg/m 	64-5558-5559 1.723 kg/m
64-3944-3945 1.823 kg/m 	64-3566-3567 1.830 kg/m 	64-1714-1715 1.961 kg/m 	64-5569-5570 1.706 kg/m
64-5568-5569 1.710 kg/m 	64-5569-5573 1.513 kg/m 	64-8442-8443 2.232 kg/m 	64-5571-5572 1.493 kg/m
64-5588-5589 1.803 kg/m 	64-5525-5526 2.201 kg/m 	64-5150-5151 1.704 kg/m 	64-12097-12098 1.948 kg/m
64-5160-5161 2.090 kg/m 	64-5574-5575 2.118 kg/m 	64-5585-5586 2.095 kg/m 	64-4303-4304 2.143 kg/m
64-3568-3569 2.158 kg/m 	64-1724-1725 2.578 kg/m 	64-3570-3571 2.420 kg/m 	64-4359-4360 2.205 kg/m
64-5576-5577 2.131 kg/m 	64-3574-3575 2.469 kg/m 	64-5162-5163 2.568 kg/m 	64-1950-1951 2.626 kg/m



WD64 THERMO SERİSİ

WD64 THERMO SERIES

(24 mm'lik ısı yalıtım fiili kullanılır)
(24 mm Thermal Break)

64-3578-3579
1.588 kg/m

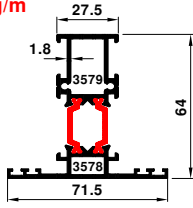

64-1700-1716
1.457 kg/m

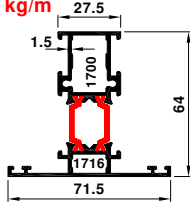

64-1702-1761
1.640 kg/m

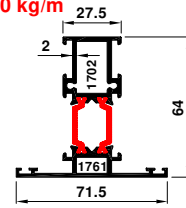

64-3576-3577
1.356 kg/m

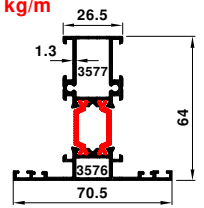

64-1640-1641
1.805 kg/m

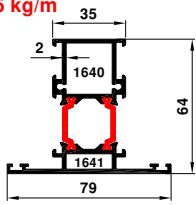

64-5564-5565
1.481 kg/m

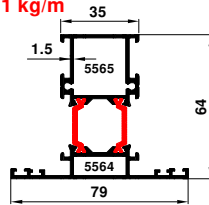

64-6500-6501
1.714 kg/m

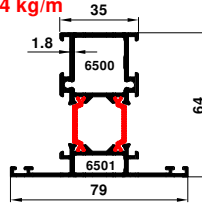

64-5566-5567
1.733 kg/m

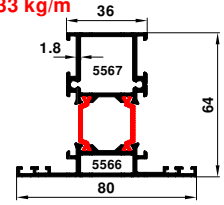

64-3637-3638
1.576 kg/m

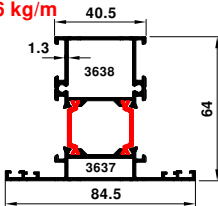

64-3639-3640
1.852 kg/m

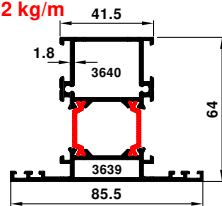

64-1706-1718
1.958 kg/m

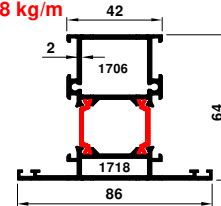

64-1704-1717
1.695 kg/m

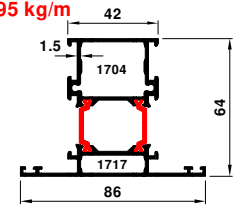

64-1650-1651
1.865 kg/m

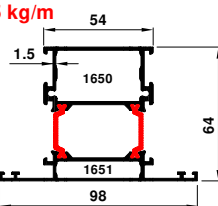

64-5521-5522
2.342 kg/m

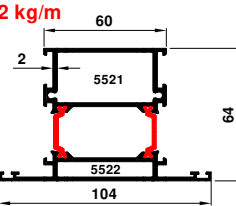

64-4300-4301
2.111 kg/m

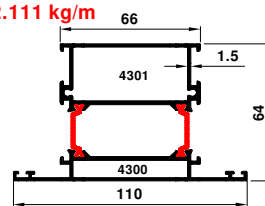

64-1719-1720
2.893 kg/m

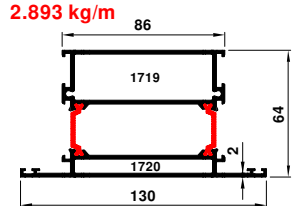

64-5154-5155
2.440 kg/m

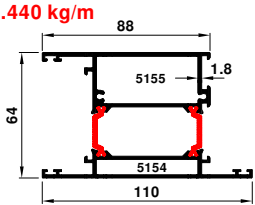

64-4300-4302
2.217 kg/m

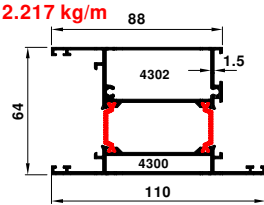

64-1720-1721
3.031 kg/m

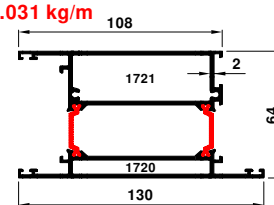

64-5523-5524
4.022 kg/m

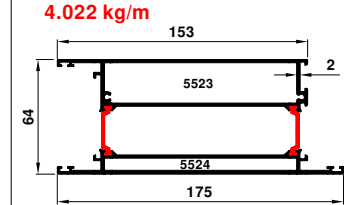

64-9788-9789
4.456 kg/m

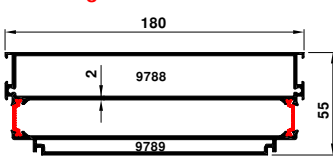

64-3640-3542
2.446 kg/m

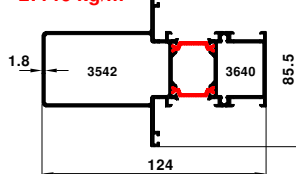

55-1718-8007
2.786 kg/m

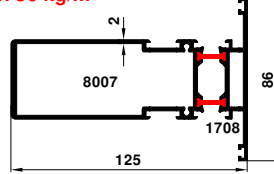

64-11924-5579
1.230 kg/m

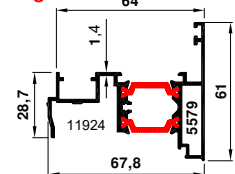

64-11923-1727
1.326 kg/m

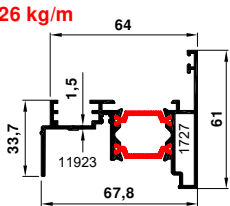

64-1734-3543
1.405 kg/m

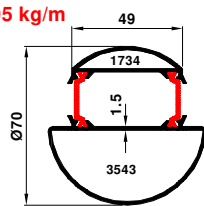

64-5547-1953
1.649 kg/m

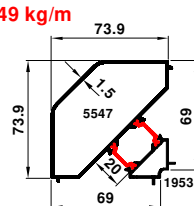

64-1728-1729
1.407 kg/m

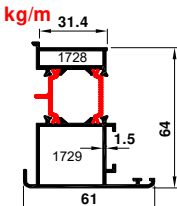

64-1762-1763
1.190 kg/m

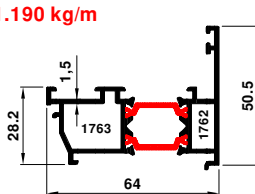

1911
0.425 kg/m

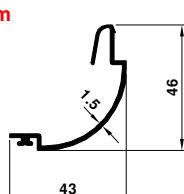

1681
0.340 kg/m

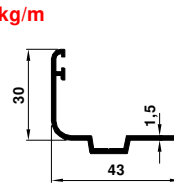

1912
0.211 kg/m

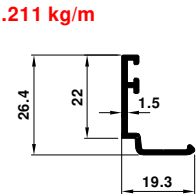



WD64 THERMO SERİSİ

WD64 THERMO SERIES

(24 mm'lik ısı yalıtım fitili kullanılır)
(24 mm Thermal Break)

1773 0.985 kg/m 	1774 0.365 kg/m 	1722 0.623 kg/m 	64-4356-4357 1.000 kg/m
1011 0.402 kg/m 	7021 0.140 kg/m 	4242 0.094 kg/m 	4358 0.316 kg/m
12375 0.326 kg/m 	10923 0.295 kg/m 	8241 0.099 kg/m 	1755 0.234 kg/m
2052 1.724 kg/m 	1764 0.312 kg/m 	11416 0.135 kg/m 	1662 2.576 kg/m
1695 2.540 kg/m 	1661 3.629 kg/m 	3546 3.357 kg/m 	1663 3.526 kg/m
1696 3.340 kg/m 	7022 3.952 kg/m 	7040 3.998 kg/m 	1664 3.991 kg/m
597 4.241 kg/m 	3698 4.604 kg/m 	3547 4.884 kg/m 	1398 5.089 kg/m
1760 8.436 kg/m 	1736 0.210 kg/m 	1948 0.235 kg/m 	1698 0.270 kg/m

1704,1706,1717,1718,1783 ve 2096 nolu profiller ile çalışır.
Works with profiles 1704-1706-1717-1718-1783 and 2096

1640,1641,1642,1643 nolu profillerin köşe takozu
Corner connection for profiles 1640,1641,1642 and 1643



WD64 THERMO SERİSİ

WD64 THERMO SERIES

(24 mm'lik ısı yalıtım fitili kullanılır)
(24 mm Thermal Break)

3539 0.277 kg/m 	1699 0.285 kg/m 	1745 0.292 kg/m 	1949 0.306 kg/m
2236 0.310 kg/m 	1966 0.314 kg/m 	3636 0.321 kg/m 	3536 0.329 kg/m
1747 0.340 kg/m 	1749 0.356 kg/m 	3537 0.367 kg/m 	5546 0.271 kg/m
1746 0.279 kg/m 	5527 0.293 kg/m 	1748 0.327 kg/m 	1750 0.342 kg/m

HEMYÜZ SİSTEM (Birlikte çalışırlar ,Orta kayıt ve Etek Profilleri Kanat Profili içerisinde ek olarak kullanılabilir.)

SYMMETRICAL SYSTEM (These profiles work together. Mullion and End profiles can be used with in sash profiles.)

64-1737-1738 1.731 kg/m 	64-1739-1740 1.742 kg/m 	64-1741-1742 2.425 kg/m 	64-1743-1744 2.421 kg/m
64-1730-1731 1.096 kg/m 	64-1732-1733 1.097 kg/m 		



HVT67 THERMO SERİSİ

HVT67 THERMO SERIES

67-11619-11628
1.640 kg/m

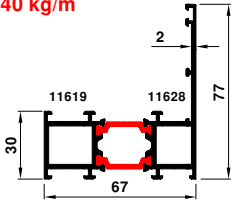

67-11620-11629
1.530 kg/m

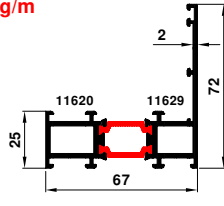

67-11618-11619
1.785 kg/m

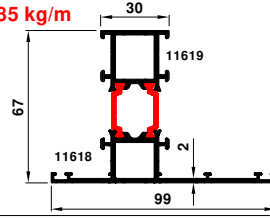

67-11620-11621
1.670 kg/m

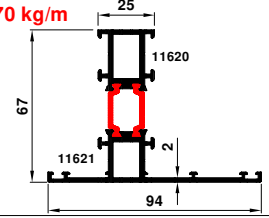

67-11619-11632
1.930 kg/m

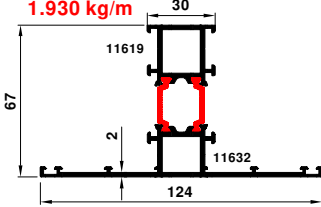

67-11619-12262
4.040 kg/m

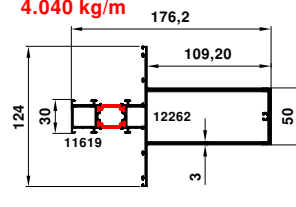

67-11624-11622
1.473 kg/m

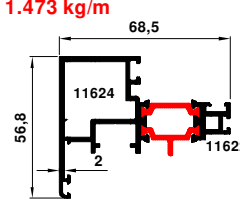

67-11623-11622
1.446 kg/m

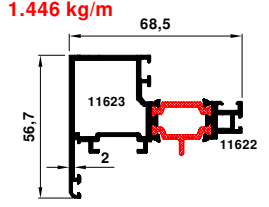

67-11631-11630
1.690 kg/m

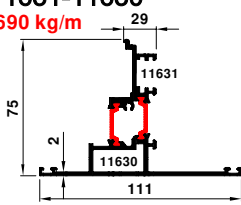

11617
0.359 kg/m

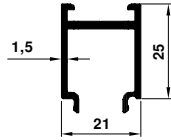

11616
0,117 kg/m

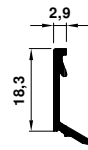

3536
0.329 kg/m

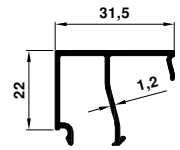

3636
0.321 kg/m

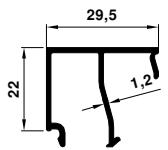

3832
0.175 kg/m

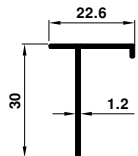

2045
1.436 kg/m



11627
2.929 kg/m

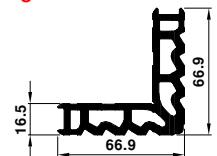

3088
3.498 kg/m

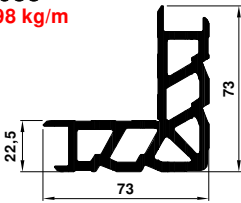

1696
3.340 kg/m

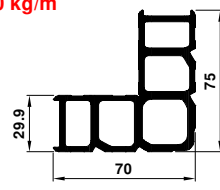

5022
2.245 kg/m

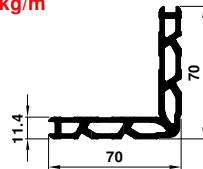

8241
0.099 kg/m



11625
0,990 kg/m

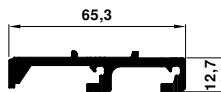

11626
1.502 kg/m





HVT77 THERMO SERİSİ

HVT77 THERMO SERIES

77-11619-11628
1.727 kg/m

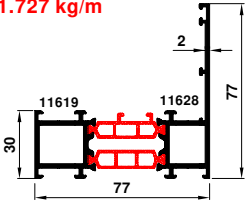

77-11620-11629
1.617 kg/m

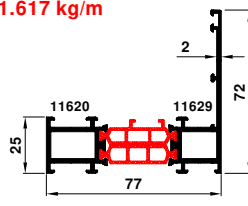

77-11618-11619
1.869 kg/m

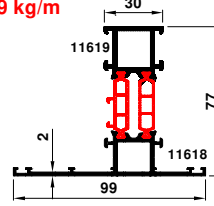

77-11620-11621
1.754 kg/m

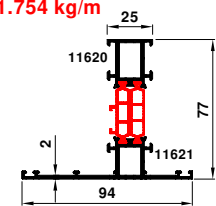

77-11619-11632
2.025 kg/m

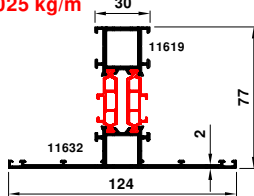

77-11619-12262
4.217 kg/m

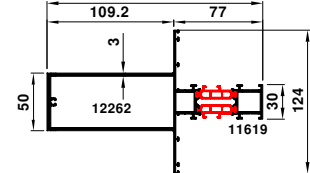

77-11624-11622
1.530 kg/m

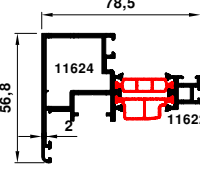

77-11623-11622
1.501 kg/m

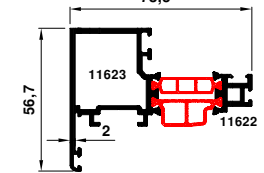

77-11631-11630
1.868 kg/m

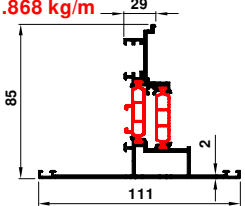

77-12260-12261
1.407 kg/m

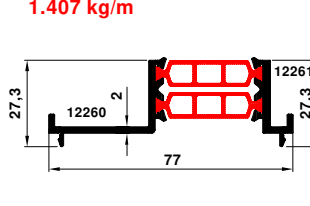

77-12350-1953
2.188 kg/m

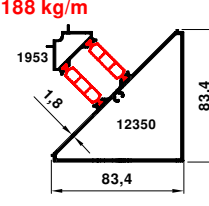

2045
1.436 kg/m

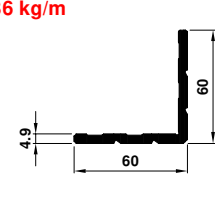

11617
0.359 kg/m

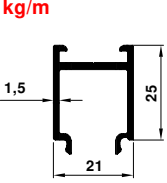

11616
0,117 kg/m

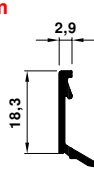

11627
2.929 kg/m

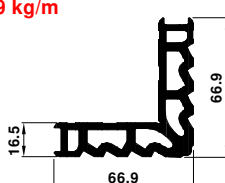

3088
3.498 kg/m

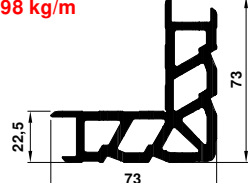

1696
3.340 kg/m

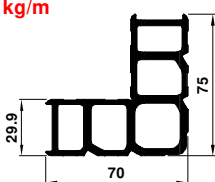

5022
2.245 kg/m

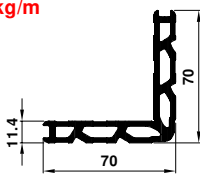

8241
0.099 kg/m

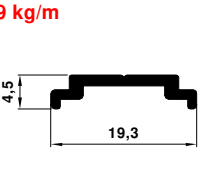

11625
0,990 kg/m

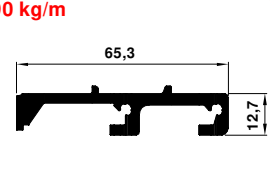

11626
1.502 kg/m

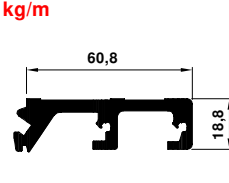

1747
0.340 kg/m

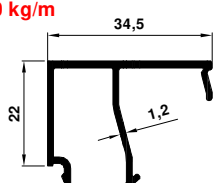



WD70 THERMO SERİSİ

WD70 THERMO SERIES

70-7004-7005
1.466 kg/m

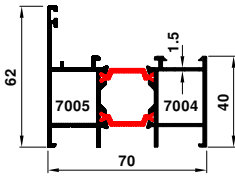

70-8764-11886
1.523 kg/m

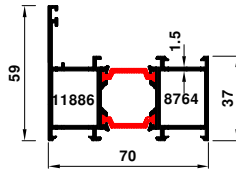

70-6880-6879
1.625 kg/m

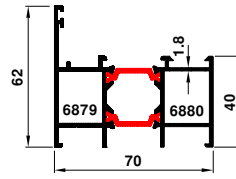

70-7004-7006
1.632 kg/m

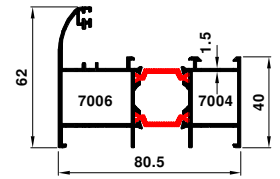

70-7004-7007
1.824 kg/m

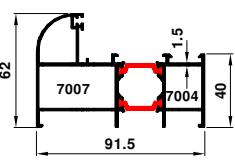

70-7038-7005
1.737 kg/m

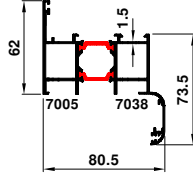

70-7038-7006
1.902 kg/m

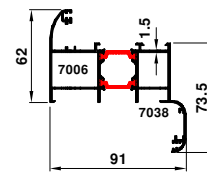

70-7038-7007
2.095 kg/m

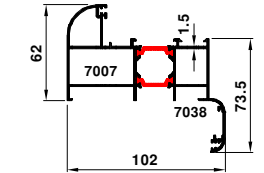

70-7055-7054
2.102 kg/m

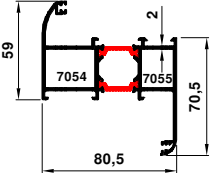

70-7000-7001
1.515 kg/m

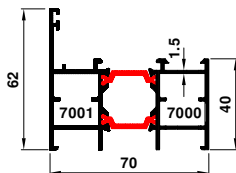

70-7000-7002
1.773 kg/m

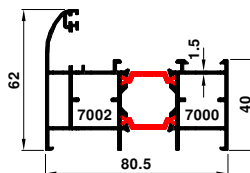

70-7176-7177
2.017 kg/m

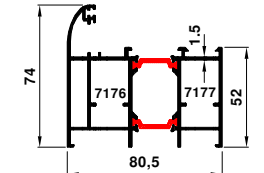

70-7037-7001
1.786 kg/m

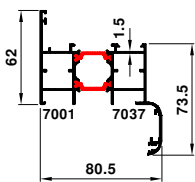

70-7037-7002
2.044 kg/m

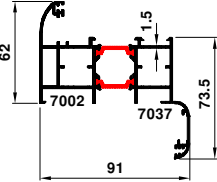

70-8764-12789
2.180 kg/m

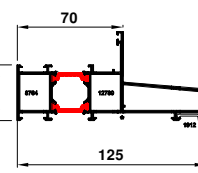

70-7016-7009
1.432 kg/m

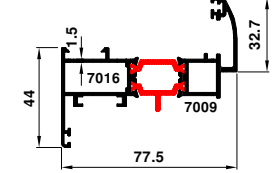

70-7008-7009
1.451 kg/m

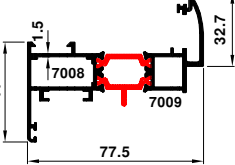

70-7017-7011
1.622 kg/m

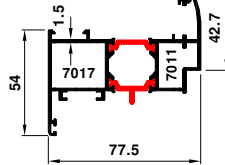

70-7048-7049
1.928 kg/m

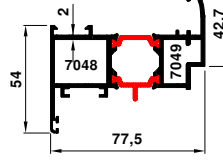

70-7010-7011
1.650 kg/m

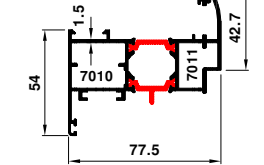

70-7018-7011
1.678 kg/m

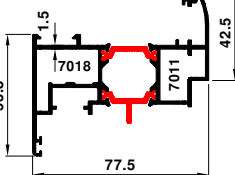

70-7058-7059
1.860 kg/m

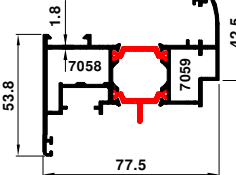

70-7041-7042
1.834 kg/m

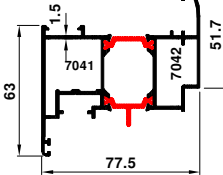

70-7012-7013
1.970 kg/m

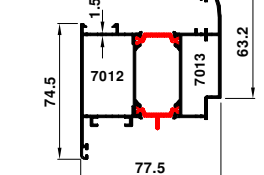

70-7015-7014
1.970 kg/m

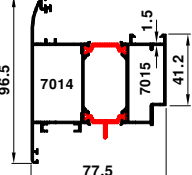

70-7013-7019
2.015 kg/m

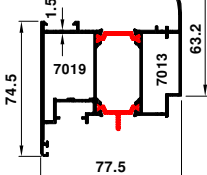

70-7015-7020
2.015 kg/m

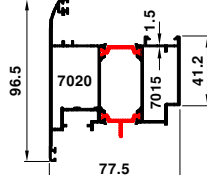

70-7025-7024
1.664 kg/m

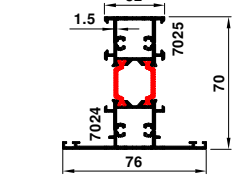

70-7051-7050
2.083 kg/m

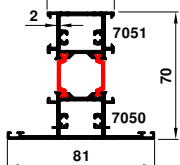

70-7047-7046
2.129 kg/m

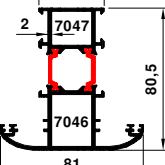

70-7027-7026
1.989 kg/m

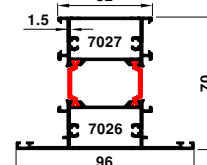

70-8764-8763
1.680 kg/m

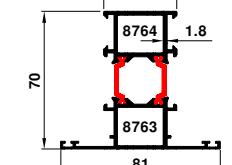



WD70 THERMO SERİSİ

WD70 THERMO SERIES

70-7045-7044
1.633 kg/m

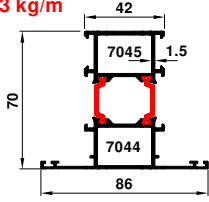

70-7057-7056
2.011 kg/m

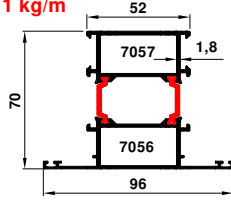

70-8764-7175
2.466 kg/m

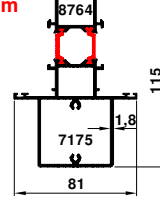

70-7051-11851
1.907 kg/m

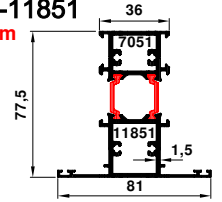

(7010-11824)*(7012-11825)*(7015-11826)*(11828-11825) Profillerle kullanılır.
(7010-11824)*(7012-11825)*(7015-11826)*(11828-11825) used with profiles.

70-7010-11824
1.570 kg/m

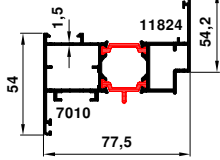

70-7017-11824
1.537 kg/m

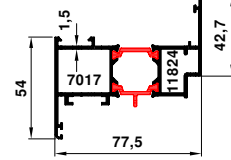

70-7012-11825
1.880 kg/m

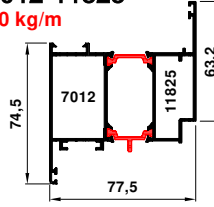

70-11828-7013
2.008 kg/m

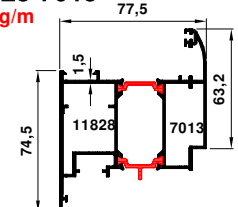

70-11828-11825
1.930 kg/m

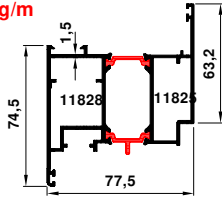

70-7015-11829
2.007 kg/m

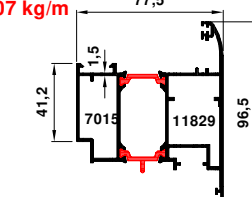

70-7015-11826
1.860 kg/m

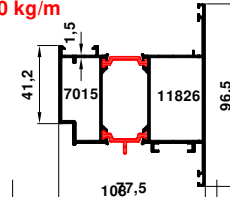

70-12096-7030
2.697 kg/m

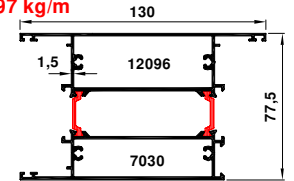

70-7028-7029
2.542 kg/m

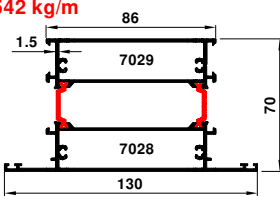

70-7028-7030
2.647 kg/m

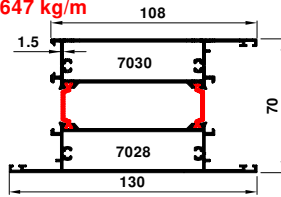

70-10628-10629
1.304 kg/m

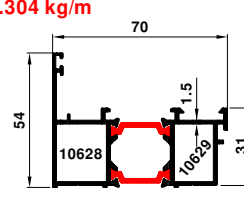

70-7179-7178
1.019 kg/m

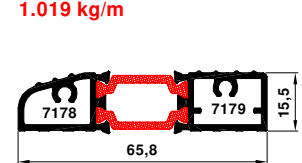

70-7033-7034
1.531 kg/m

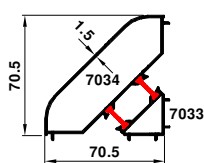

70-7033-7035
1.894 kg/m

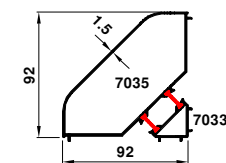

70-11927-7031
1.349 kg/m

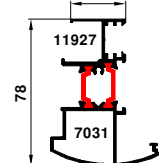

70-11926-7031
1.340 kg/m

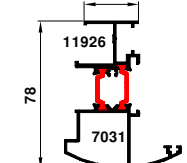

70-11926-11827
1.280 kg/m

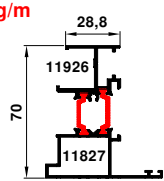

70-11927-11827
1.290 kg/m

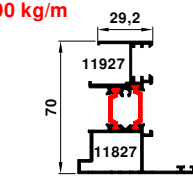

55-1734-1735
1.465 kg/m

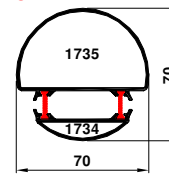

70-1734-1735
1.481 kg/m

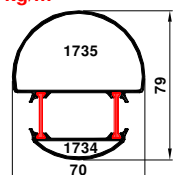

7060
1.007 kg/m

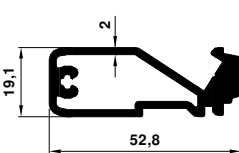

10923
0.295 kg/m

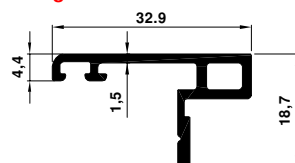

7021
0.140 kg/m

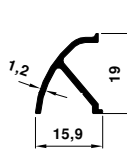

12375
0.326 kg/m

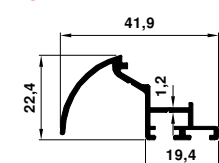

4242
0.094 kg/m

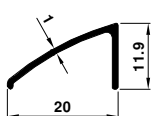

7180
0.244 kg/m

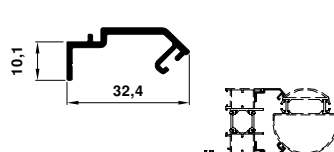

1011
0.402 kg/m

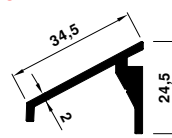

8241
0.099 kg/m

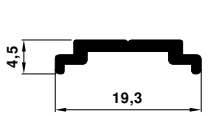



WD70 THERMO SERİSİ

WD70 THERMO SERIES











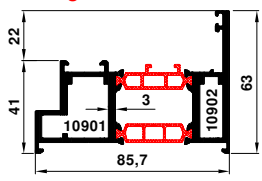

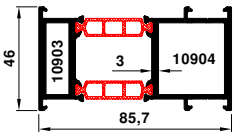

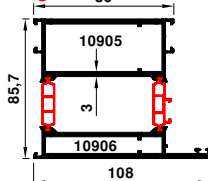

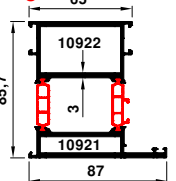

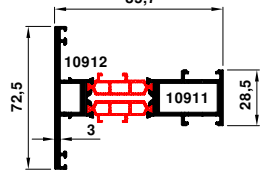
413 3.667 kg/m 	3546 3.357 kg/m 	7040 3.998 kg/m 	1662 2.576 kg/m
5022 2.245 kg/m 	3088 3.498 kg/m 	1661 3.629 kg/m 	1663 3.526 kg/m
7022 3.952 kg/m 	3698 4.604 kg/m 	1664 3.991 kg/m 	7023 0.294 kg/m
7036 0.319 kg/m 	676 0.331 kg/m 	7043 0.366 kg/m 	1948 0.235 kg/m
1698 0.270 kg/m 	3539 0.277 kg/m 	1699 0.285 kg/m 	1745 0.292 kg/m
1949 0.306 kg/m 	2236 0.310 kg/m 	1966 0.314 kg/m 	3636 0.321 kg/m
3536 0.329 kg/m 	1747 0.340 kg/m 	1749 0.356 kg/m 	3537 0.367 kg/m
13173 0.643 kg/m 			

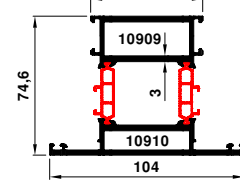
7046,7047,7048,7049 nolu profillerin köşe takozu
Corner connection for profiles 7046,7047,7048,7049

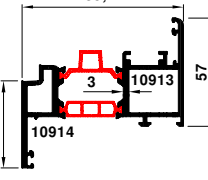

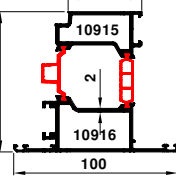
WD86 THERMO SERİSİ

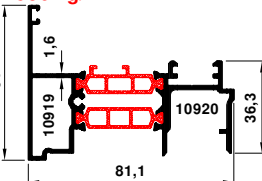
WD86 THERMO SERIES

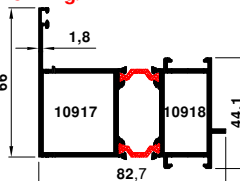
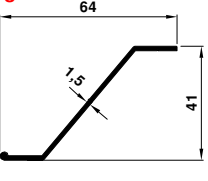
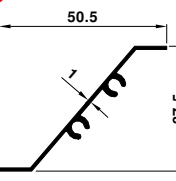
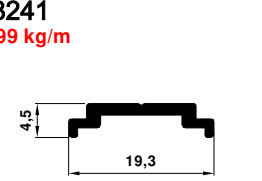
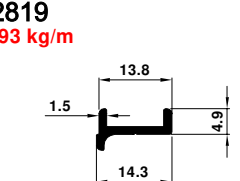
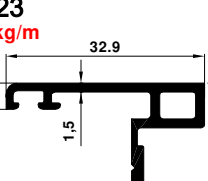
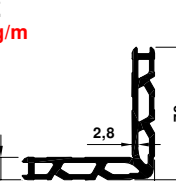
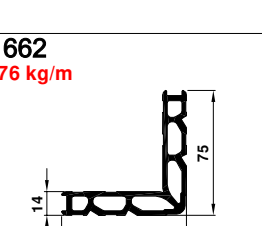
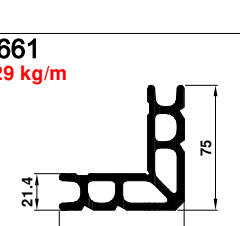
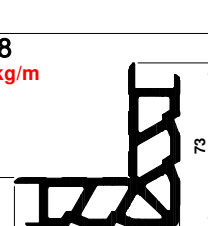
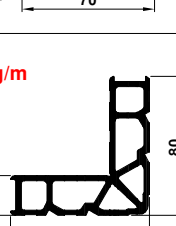
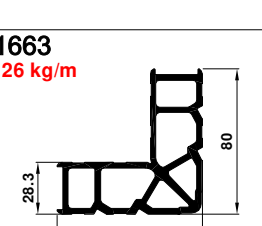
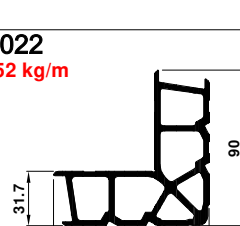
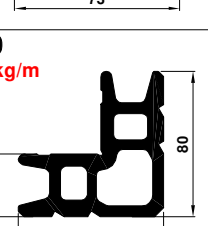
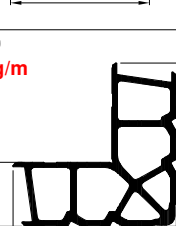
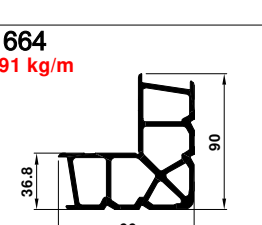
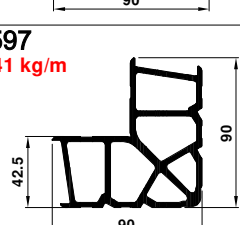
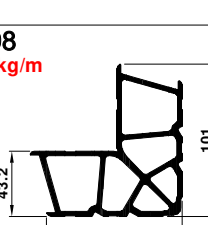
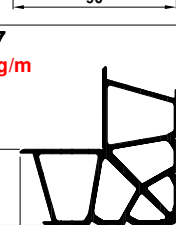
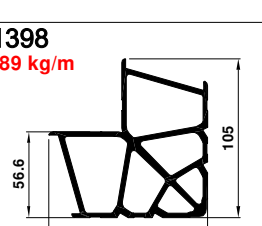
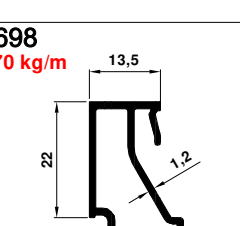
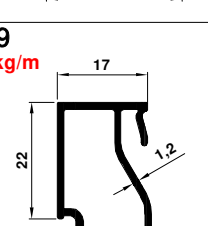
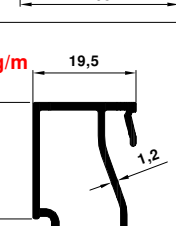
86-10901-10902 2.341 kg/m  	86-10903-10904 2.176 kg/m  	86-10905-10906 3.763 kg/m  	86-10921-10922 3.075 kg/m  
86-10911-10912 2.136 kg/m  	86-10909-10910 3.036 kg/m  	86-10913-10914 2.446 kg/m  	86-10915-10916 2.515 kg/m  
86-10919-10920 1.956 kg/m  	86-10917-10918 1.914 kg/m  	175 0.345 kg/m 	4904 0.264 kg/m 
8241 0.099 kg/m 	2819 0.093 kg/m 	10923 0.295 kg/m 	5022 2.245 kg/m 
1662 2.576 kg/m 	1661 3.629 kg/m 	3088 3.498 kg/m 	3546 3.357 kg/m 
1663 3.526 kg/m 	7022 3.952 kg/m 	410 6.094 kg/m 	7040 3.998 kg/m 
1664 3.991 kg/m 	597 4.241 kg/m 	3698 4.604 kg/m 	3547 4.884 kg/m 
1398 5.089 kg/m 	1698 0.270 kg/m 	3539 0.277 kg/m 	1699 0.285 kg/m 



WD86 THERMO SERİSİ

WD86 THERMO SERIES

<p>1745 0.292 kg/m</p> <p>22, 21,5, 1,2</p>	<p>1949 0.306 kg/m</p> <p>22, 25,5, 1,2</p>	<p>2236 0.310 kg/m</p> <p>22, 26,5, 1,2</p>	<p>1966 0.314 kg/m</p> <p>22, 27,5, 1,2</p>
<p>3636 0.321 kg/m</p> <p>22, 29,5, 1,2</p>	<p>3536 0.329 kg/m</p> <p>22, 31,5, 1,2</p>	<p>1747 0.340 kg/m</p> <p>22, 34,5, 1,2</p>	<p>1749 0.356 kg/m</p> <p>22, 38,5, 1,2</p>
<p>3537 0.367 kg/m</p> <p>22, 41,5, 1,2</p>	<p>1748 0.327 kg/m</p> <p>22, 34,5, 1,2</p>	<p>1750 0.342 kg/m</p> <p>22, 38,5, 1,2</p>	



SH110 GİYOTİN SERİSİ

SH110 GUILLOTINE SERIES

<p>10550 2.978 kg/m</p> <p>170 134</p>	<p>10551 1.186 kg/m</p> <p>169 45</p>	<p>10552 1.927 kg/m</p> <p>90.3 109.5</p>	<p>10553 0.492 kg/m</p> <p>76.8 12.2</p>
<p>10554 0.637 kg/m</p> <p>38 25</p>	<p>10555 0.761 kg/m</p> <p>38 25</p>	<p>10556 0.411 kg/m</p> <p>40.6 23</p>	<p>10557 0.245 kg/m</p> <p>34.6 18.1</p>
<p>10558 0.633 kg/m</p> <p>33.5 25 3</p>	<p>10559 1.045 kg/m</p> <p>99.5 26.9 1.3</p>	<p>8063 0.137 kg/m</p> <p>41.6 8.9</p>	<p>5992 0.080 kg/m</p> <p>15 6.9</p>
<p>8241 0.099 kg/m</p> <p>4.5 19.3</p>			



AD40 ECO AYARLI KAPI SERİSİ
AD40 ECO ADJUSTABLE DOOR SERIES

12799
1.095 kg/m

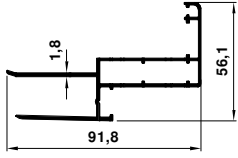

12800
0.389 kg/m

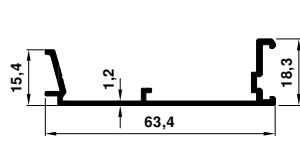

12801
0.567 kg/m

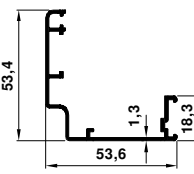

12802
0.738 kg/m

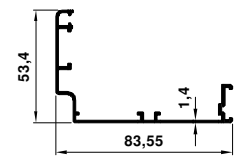

12803
0.906 kg/m

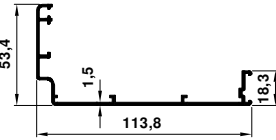

12804
1.280 kg/m

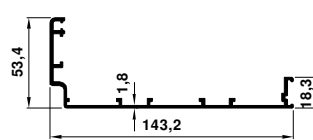

12805
1.639 kg/m

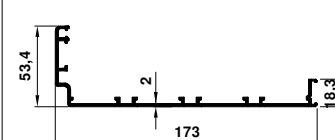

12806
2.155 kg/m

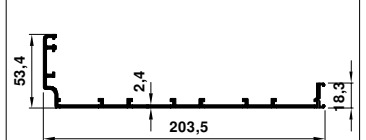



AD40-AD55 AYARLI KAPI SERİSİ

AD40-AD55 ADJUSTABLE DOOR SERIES

<p>2173 1.671 kg/m</p> <p>AD40</p>	<p>1924 1.372 kg/m</p> <p>AD40</p>	<p>2172 1.841 kg/m</p> <p>AD55</p>	<p>1923 1.516 kg/m</p> <p>AD55</p>
<p>7208 1.628 kg/m</p> <p>AD40</p>	<p>1926 0.880 kg/m</p> <p>AD40</p>	<p>1925 0.758 kg/m</p> <p>AD40</p>	<p>2174 0.996 kg/m</p> <p>AD40</p>
<p>1927 1.064 kg/m</p> <p>AD40</p>	<p>2176 1.191 kg/m</p> <p>AD40</p>	<p>8750 0.874 kg/m</p> <p>AD40</p>	<p>2175 1.099 kg/m</p> <p>AD40</p>
<p>7209 1.262 kg/m</p> <p>AD40</p>	<p>1928 1.211 kg/m</p> <p>AD40</p>	<p>2247 1.414 kg/m</p> <p>AD40</p>	<p>7090 1.456 kg/m</p> <p>AD40</p>
<p>2248 1.555 kg/m</p> <p>AD40</p>	<p>7210 1.555 kg/m</p> <p>AD40</p>	<p>2249 1.707 kg/m</p> <p>AD40</p>	<p>1929 0.683 kg/m</p> <p>AD40</p>
<p>1930 0.688 kg/m</p> <p>AD40</p>	<p>7580 0.907 kg/m</p> <p>AD40</p>	<p>7696 0.421 kg/m</p> <p>AD40</p>	<p>1931 0.688 kg/m</p> <p>AD40</p>
<p>8585 0.202 kg/m</p> <p>AD40</p>	<p>8557 0.627 kg/m</p> <p>AD40</p>	<p>5992 0.080 kg/m</p> <p>AD40</p>	<p>4923 0.174 kg/m</p> <p>AD40</p>
<p>164 0.824 kg/m</p> <p>AD40</p>	<p>3926 0.625 kg/m</p> <p>AD40</p>		



FD60 THERMO KATLANIR KAPI SERİSİ

FD60 THERMO BI-FOLD DOOR SERIES

3663-3664 2.664 kg/m 	3662-3662 1.402 kg/m 	3660-3661 1.764 kg/m 	13006-13007 1.615 kg/m
3665-3665 1.108 kg/m 	3669 0.199 kg/m 	3668 0.237 kg/m 	3666-3666 1.306 kg/m
3666-3667 1.357 kg/m 	11832-11833 1.315 kg/m 	11834-11833 1.433 kg/m 	3667-3667 1.364 kg/m
11830-11831 1.288 kg/m 	11835-11836 2.029 kg/m 	13008 0.205 kg/m 	7241 0.084 kg/m
8241 0.099 kg/m 	1948 0.235 kg/m 	1698 0.270 kg/m 	3539 0.277 kg/m
1699 0.285 kg/m 	1745 0.292 kg/m 	1949 0.306 kg/m 	2236 0.310 kg/m
1966 0.314 kg/m 	3636 0.321 kg/m 	3536 0.329 kg/m 	1747 0.340 kg/m
1749 0.356 kg/m 	3537 0.367 kg/m 	5546 0.271 kg/m 	1746 0.279 kg/m



FD60 THERMO KATLANIR KAPI SERİSİ



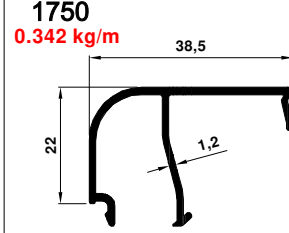
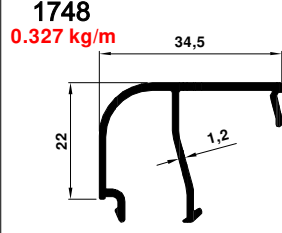
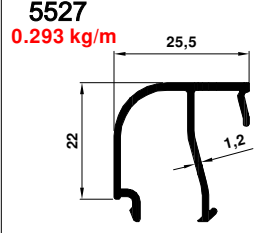







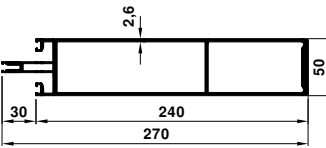
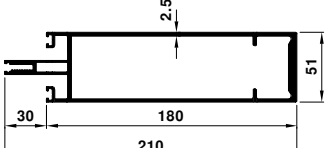
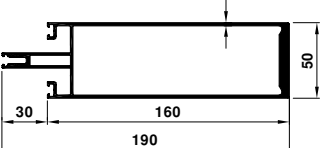
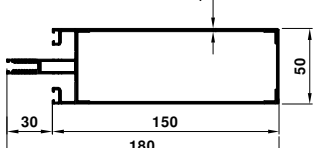
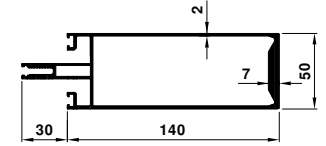
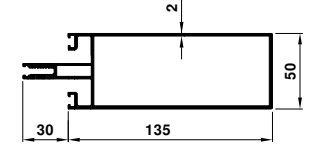
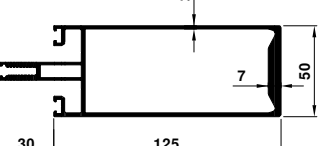

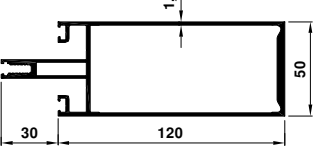
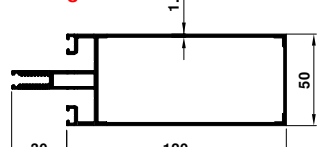
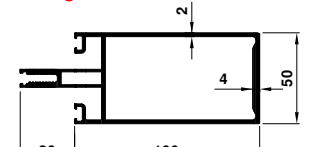
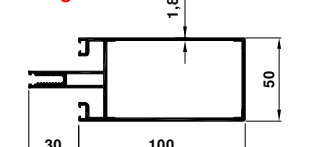
FD60 THERMO BI-FOLD DOOR SERIES

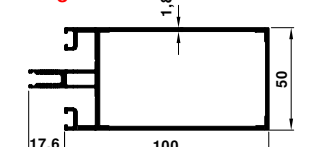
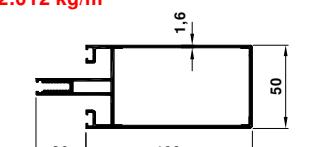

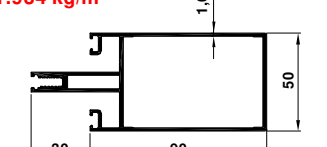
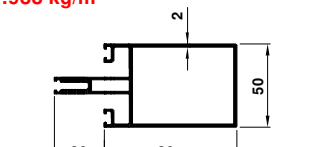
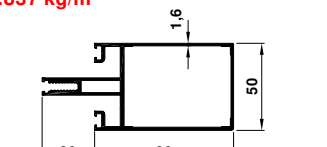
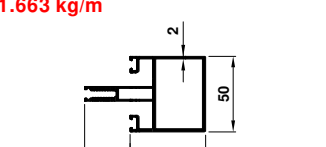
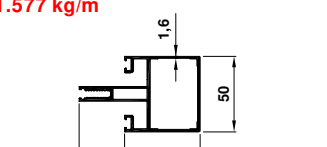
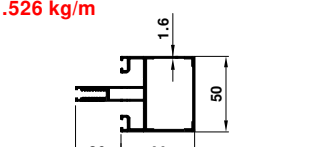
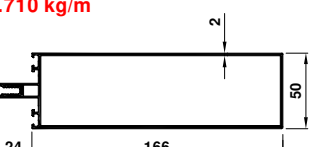

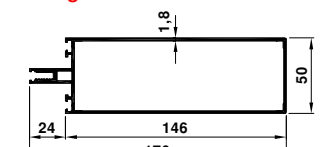
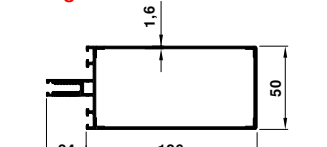
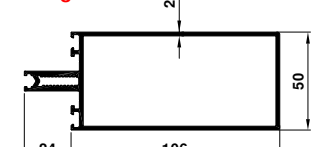
FS50 CEPHE SERİSİ

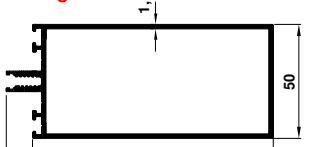
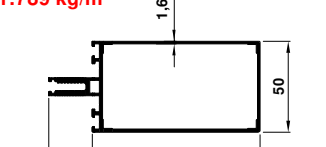
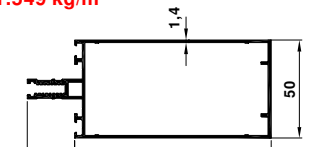
FS50 FACADE SERIES

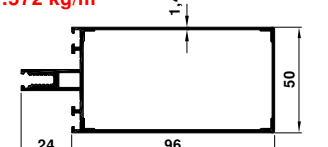
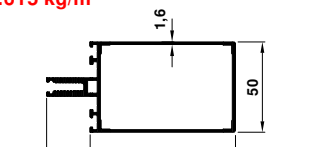
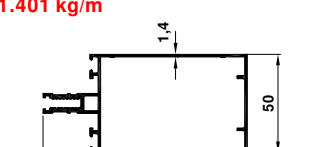
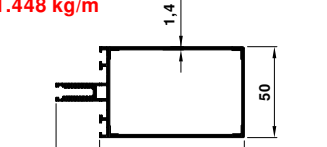
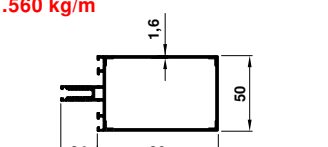
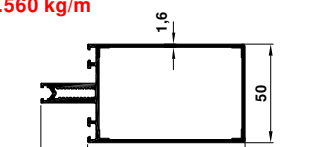
13084 5.498 kg/m  	5090 4.217 kg/m 	12264 3.436 kg/m 	5078 2.644 kg/m 
5001 3.133 kg/m 	5000 2.585 kg/m 	5003 2.970 kg/m 	13085 2.531 kg/m  
5002 2.185 kg/m 	5005 2.411 kg/m 	5127 2.109 kg/m 	12423 1.961 kg/m  
5004 2.012 kg/m 	13083 1.934 kg/m  	5007 1.988 kg/m 	5006 1.837 kg/m 
5009 1.663 kg/m 	5008 1.577 kg/m 	5115 1.526 kg/m 	12263 2.710 kg/m 
13086 2.329 kg/m  	5095 1.961 kg/m 	9733 2.055 kg/m 	12424 1.717 kg/m  
5096 1.789 kg/m 	8454 1.549 kg/m 	13087 1.572 kg/m  	5121 1.615 kg/m 
5120 1.401 kg/m 	9650 1.448 kg/m 	5010 1.560 kg/m 	5126 1.560 kg/m 



FS50 CEPHE SERİSİ

FS50 FACADE SERIES

5125 1.685 kg/m 	5011 1.432 kg/m 	5012 1.302 kg/m 	5122 1.166 kg/m
5013 1.130 kg/m 	5063-5067 1.215 kg/m 	5064-5067 1.169 kg/m 	5065-5067 1.214 kg/m
5023 0.094 kg/m 	5063-5066 1.251 kg/m 	5064-5066 1.205 kg/m 	5065-5066 1.250 kg/m
5029-5030-12 1.250 kg/m 	13105-13106 1.014 kg/m 	5093 0.766 kg/m 	5081 0.908 kg/m
5062 0.918 kg/m 	5027 0.128 kg/m 	5088 1.027 kg/m 	5028 1.037 kg/m
5031 1.093 kg/m 	5099 1.013 kg/m 	5068 0.634 kg/m 	5114 1.974 kg/m
5032 0.727 kg/m 	5071 0.783 kg/m 	5117 1.014 kg/m 	5116 0.263 kg/m
5056 0.478 kg/m 	5033 0.508 kg/m 	5075 0.573 kg/m 	5035 0.518 kg/m

!!! 5119-12920 Profil ile çalışır
Works with profile 5119-12920



FS50 CEPHE SERİSİ

FS50 FACADE SERIES

5074 0.556 kg/m 	5072 0.524 kg/m 	5069 0.470 kg/m 	5014 2.750 kg/m
5015 2.703 kg/m 	5057 0.248 kg/m 	5026 0.233 kg/m 	5058 0.244 kg/m
12333 0.285 kg/m 	12332 0.393 kg/m 	5094 0.340 kg/m 	5039 0.280 kg/m
5070 0.252 kg/m 	5060 0.172 kg/m 	5077 0.126 kg/m 	5036 0.339 kg/m
5037 0.340 kg/m 	13088 0.272 kg/m 	2006 0.385 kg/m 	5123 0.340 kg/m
2009 0.439 kg/m 	13089 0.728 kg/m 	5047 0.369 kg/m 	5046 0.334 kg/m
5045 0.380 kg/m 	2049 0.331 kg/m 	2050 0.403 kg/m 	9691 1.498 kg/m
7619 0.337 kg/m 	5052 0.515 kg/m 	5048 0.466 kg/m 	5124 0.430 kg/m





5080 1.106 kg/m 	5051 1.253 kg/m 	5050 1.635 kg/m 	5049 1.874 kg/m
10065 2.719 kg/m 	8369 4.515 kg/m 	5043 0.961 kg/m 	5044 1.260 kg/m
12920 0.516 kg/m 	5119 0.384 kg/m 	5020 2.137 kg/m 	5021 2.467 kg/m
5129 4.656 kg/m 	5019 2.226 kg/m 	5092 2.435 kg/m 	5018 2.428 kg/m
5016 2.948 kg/m 	5017 2.745 kg/m 	5091 3.193 kg/m 	5038 1.463 kg/m
13090 0.962 kg/m 	5041 2.211 kg/m 	5040 0.456 kg/m 	5042 1.144 kg/m
6121 2.026 kg/m 	13091 1.950 kg/m 	13092 0.117 kg/m 	13093 0.687 kg/m
13094 0.120 kg/m 	13095 0.728 kg/m 	13096 0.945 kg/m 	1.779 kg/m

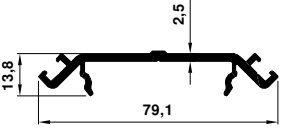
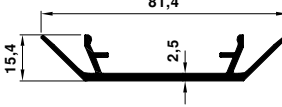
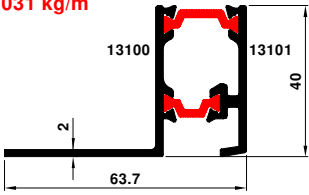
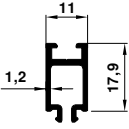
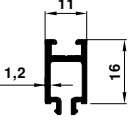
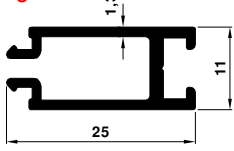
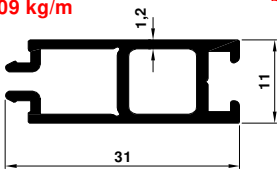
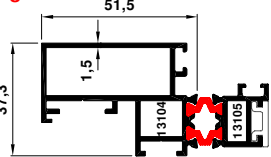

FS50 CEPHE SERİSİ

FS50 FACADE SERIES

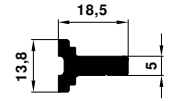
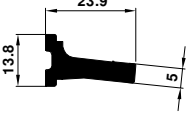
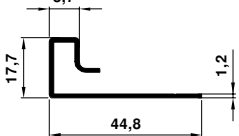
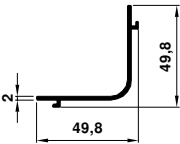
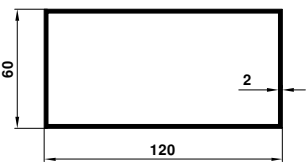
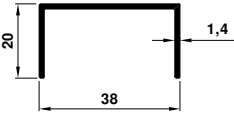
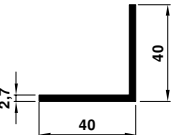
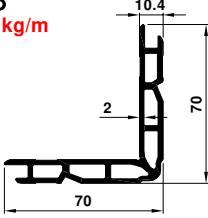
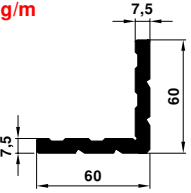
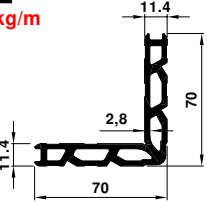
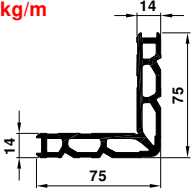
<p>13098 0.749 kg/m</p> 	<p>13099 0.688 kg/m</p> 	<p>13100-13101 1.031 kg/m</p> 	<p>5059 0.210 kg/m</p> 
<p>5097 0.198 kg/m</p> 	<p>13102 0.250 kg/m</p> 	<p>13103 0.309 kg/m</p> 	<p>13104-13105 0.910 kg/m</p> 
<p>8241 0.099 kg/m</p> 	<p>5024 0.323 kg/m</p> 	<p>5079 0.404 kg/m</p> 	<p>5034 0.267 kg/m</p> 
<p>5076 0.515 kg/m</p> 	<p>419 1.908 kg/m</p> 	<p>5164 0.285 kg/m</p> 	<p>1533 0.566 kg/m</p> 
<p>598 1.677 kg/m</p> 	<p>2046 2.091 kg/m</p> 	<p>5022 2.245 kg/m</p> 	<p>1662 2.576 kg/m</p> 



FS50 ECO CEPHE SERİSİ

FS50 ECO FACADE SERIES

6100 2.421 kg/m 	6101 2.796 kg/m 	6102 1.854 kg/m 	6103 2.148 kg/m
6104 1.681 kg/m 	6105 1.931 kg/m 	6106 1.508 kg/m 	6107 1.715 kg/m
6108 1.334 kg/m 	6109 1.498 kg/m 	9888 2.137 kg/m 	6133 1.369 kg/m
12423 1.961 kg/m 	12424 1.717 kg/m 	6112 0.985 kg/m 	6110-6111 1.241 kg/m
6113-6114 1.317 kg/m 	6115 0.411 kg/m 	6116 0.530 kg/m 	8241 0.099 kg/m
9748 0.419 kg/m 	6117 0.254 kg/m 	6122 3.119 kg/m 	6123 2.753 kg/m
6125 2.483 kg/m 	6124 2.199 kg/m 	6120 0.265 kg/m 	5129 4.656 kg/m
5040 0.456 kg/m 	5041 2.211 kg/m 	6121 2.027 kg/m 	5042 1.144 kg/m



FS50 ECO CEPHE SERİSİ

FS50 ECO FACADE SERIES

6118 0.298 kg/m 	6119 0.440 kg/m 	5022 2.245 kg/m 	1662 2.576 kg/m
5164 0.285 kg/m 	13090 0.962 kg/m 	13091 1.950 kg/m 	13092 0.125 kg/m
13093 0.687 kg/m 	13094 0.129 kg/m 	13095 0.728 kg/m 	13096 0.945 kg/m
13097 1.779 kg/m 	13098 0.749 kg/m 	13099 0.688 kg/m 	13100-13101 1.031 kg/m
13102 0.250 kg/m 	13103 0.310 kg/m 		



FS50 ECO SIZE CEPHE SERİSİ

FS50 ECO SIZE FACADE SERIES

12423 1.961 kg/m 	12424 1.717 kg/m 	5064-5066 1.205 kg/m 	5062 0.918 kg/m
5042 1.144 kg/m 	5018 2.428 kg/m 	5048 0.466 kg/m 	2006 0.385 kg/m



FS65 ÇELİK TAKVİYELİ CEPHE SERİSİ

FS65 STEEL REINFORCED FAÇADE SERIES

<p>5100 1.610 kg/m</p>	<p>5101 1.723 kg/m</p>	<p>5102 0.387 kg/m</p>	<p>5103 0.433 kg/m</p>
<p>5104 0.569 kg/m</p>	<p>5105 0.824 kg/m</p>	<p>5106 1.258 kg/m</p>	<p>5107 2.309 kg/m</p>
<p>5113 0.282 kg/m</p>	<p>5059 0.210 kg/m</p>	<p>5097 0.198 kg/m</p>	



FS70 CEPHE SERİSİ

FS70 FAÇADE SERIES

<p>2031 2.618 kg/m</p>	<p>2032 1.400 kg/m</p>	<p>2033 0.886 kg/m</p>	<p>2034 0.900 kg/m</p>
<p>2035 1.615 kg/m</p>			



SKY65 IŞIKLIK SERİSİ

SKY65 SKYLIGHT SERIES

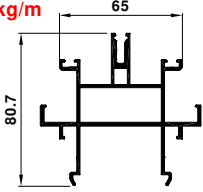
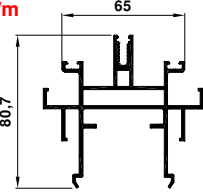
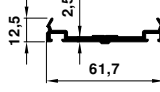
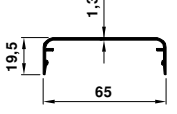
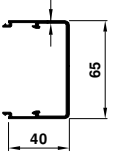
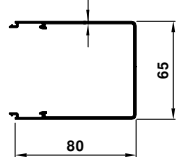
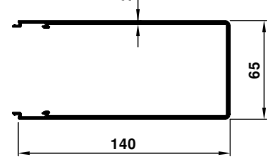
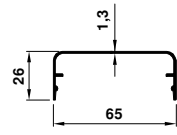
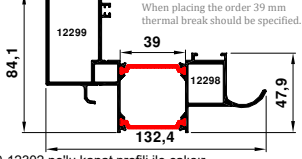
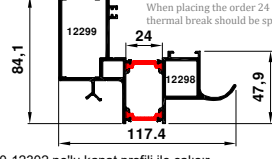
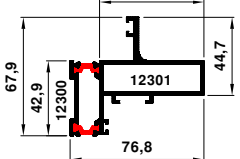
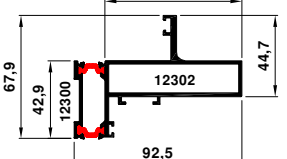
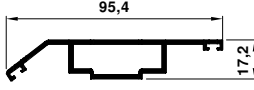
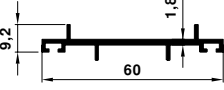
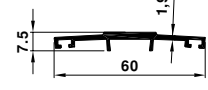
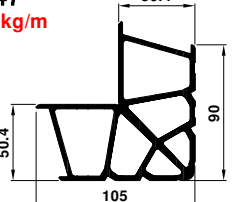
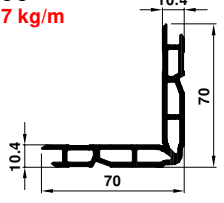
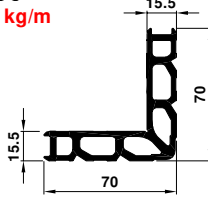
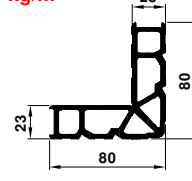
12213 1.921 kg/m 	12214 2.103 kg/m 	5104 0.569 kg/m 	5102 0.387 kg/m 
5105 0.824 kg/m 	5106 1.258 kg/m 	5107 2.309 kg/m 	5103 0.433 kg/m 
12298-12299 2.661 kg/m  <p>**Sipariş aşamasında polyamid ısı bariyerleri 39 mm olarak belirtilmelidir. When placing the order 39 mm thermal break should be specified.</p>	12298-12299 2.583 kg/m  <p>**Sipariş aşamasında polyamid ısı bariyerleri 24 mm olarak belirtilmelidir. When placing the order 24 mm thermal break should be specified.</p>	12300-12301 1.724 kg/m 	12300-12302 1.879 kg/m 
12303 0.946 kg/m  <p>12300-12302 no'lu kanat profili ile çalışır. Works with sash profiles 12300-12301</p>	172 0.388 kg/m  <p>12300-12302 no'lu kanat profili ile çalışır. Works with sash profiles 12300-12301</p>	171 0.414 kg/m 	3547 4.884 kg/m 
598 1.677 kg/m 	1695 2.540 kg/m 	3546 3.357 kg/m 	



SB GÜNEŞ KIRICI SERİSİ

SB SUNSHADE SERIES

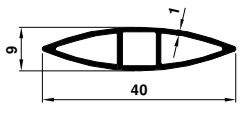
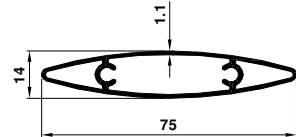
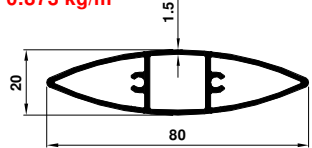
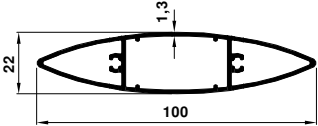
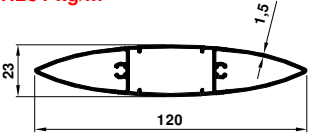
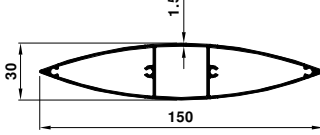
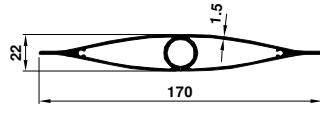
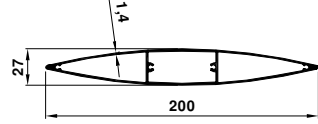
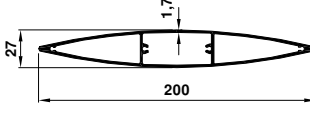
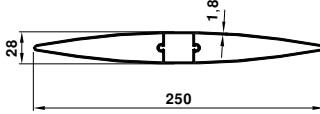
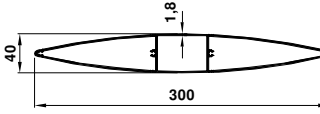
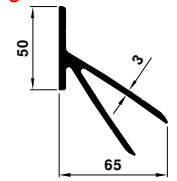
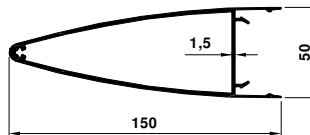
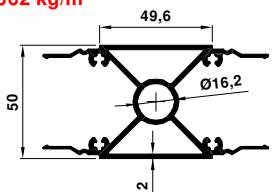
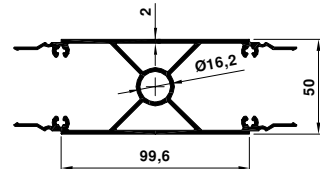
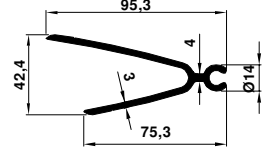
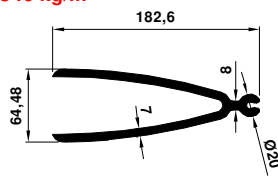
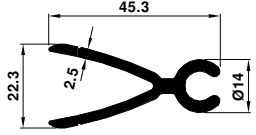
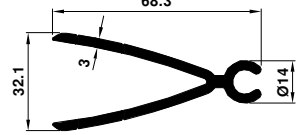
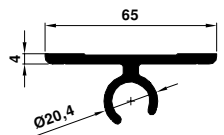
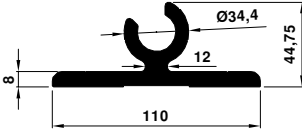
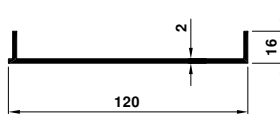
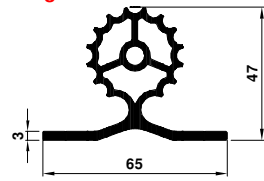
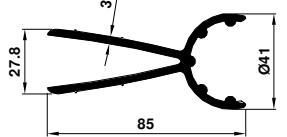
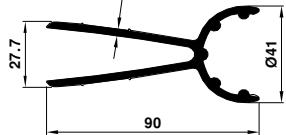
4830 0.252 kg/m 	6594 0.577 kg/m 	1982 0.873 kg/m 	6277 0.942 kg/m 
7699 1.291 kg/m 	1983 1.573 kg/m 	2036 1.713 kg/m 	9799 1.917 kg/m 
1179 2.208 kg/m 	2785 2.805 kg/m 	6275 3.457 kg/m 	6276 1.732 kg/m 
4000 1.905 kg/m 	4001 2.062 kg/m 	4004 2.666 kg/m 	4002 1.438 kg/m 
4005 6.840 kg/m 	3955 0.677 kg/m 	3956 1.135 kg/m 	4003 1.050 kg/m 
4006 3.688 kg/m 	2037 0.802 kg/m 	4197 1.500 kg/m 	4198 1.662 kg/m 
4199 1.748 kg/m 			



CP50 KOMPOZİT PANEL PROFİLLERİ

CP50 COMPOSITE PANEL PROFILES

<p>6070 0.988 kg/m</p> <p>50 55 1.5 2</p>	<p>6071 1.005 kg/m</p> <p>25.5 57 3</p>	<p>6072 0.584 kg/m</p> <p>23 40.5 1.5</p>	<p>6073 0.883 kg/m</p> <p>35.7 42 2.5</p>
<p>278 0.219 kg/m</p> <p>1.4 38.8 4.5</p>	<p>507 0.251 kg/m</p> <p>1.4 42 4.5</p>	<p>6981 0.191 kg/m</p> <p>1.2 38.8 5.5</p>	<p>3117 0.225 kg/m</p> <p>1.4 38.8 5.5</p>
<p>4037 0.217 kg/m</p> <p>1.3 40 4.8</p>	<p>7476 0.257 kg/m</p> <p>10 40 1.4</p>	<p>6549 0.323 kg/m</p> <p>20 25 1.8 25</p>	<p>513 0.184 kg/m</p> <p>26 22</p>
<p>477 0.220 kg/m</p> <p>1.3 20 23</p>	<p>8429 0.307 kg/m</p> <p>1.5 23 33</p>	<p>8428 0.386 kg/m</p> <p>1.5 33 42.2</p>	<p>8427 0.629 kg/m</p> <p>2 45 60</p>
<p>5651 0.205 kg/m</p> <p>1.1 22 27</p>	<p>9659 0.210 kg/m</p> <p>1.5 16.5 20</p>	<p>5652 0.160 kg/m</p> <p>1.1 16 24</p>	<p>8711 0.302 kg/m</p> <p>1.3 30 5 30</p>
<p>4320 0.204 kg/m</p> <p>Ø9.8</p>	<p>6937 0.576 kg/m</p> <p>2.5 27 40</p>	<p>6938 0.249 kg/m</p> <p>13 24.8 0.8 18.6</p>	<p>9790 0.529 kg/m</p> <p>1.8 50 70</p>



MF20-MS20-OP30 LOFT SİSTEM PROFİLLERİ

MF20-MS20-OP30 LOFT SYSTEM PROFILES

<p>12403 1.649 kg/m</p> <p>40 2,5 50</p>	<p>12405 0.806 kg/m</p> <p>37,6 30 2,5 15,4</p>	<p>12407 0.245 kg/m</p> <p>30 7 1,5 17,5</p>	<p>12408 0.202 kg/m</p> <p>30 7 1,5 17,5</p>
<p>12409 0.130 kg/m</p> <p>25,6 9,8 1</p>	<p>12410 1.882 kg/m</p> <p>2,8 50 60,3 57,9</p>	<p>12411 0.564 kg/m</p> <p>28,3 23,9 2,2 23,3</p>	<p>1931 0.688 kg/m</p> <p>1,5 22 40</p>
<p>5725 0.119 kg/m</p> <p>15 1 30</p>	<p>12406 1.369 kg/m</p> <p>2,5 35,8 53,2</p>	<p>12404 0.332 kg/m</p> <p>15,5 60 1,3</p>	<p>8554 1.142 kg/m</p> <p>40 52,5 1,6</p>
<p>6192 0.256 kg/m</p> <p>12 14</p>	<p>3892 0.108 kg/m</p> <p>10 1 12,4</p>	<p>2824 0.307 kg/m</p> <p>1,5 30 11</p>	



STEELLOOK LOFT SİSTEM PROFİLLERİ

STEELLOOK LOFT SYSTEM PROFILES

<p>12522 1.943 kg/m</p> <p>100 45 2</p>	<p>12523 2.617 kg/m</p> <p>150 45 2</p>	<p>12524 0.106 kg/m</p> <p>6,8 16,2</p>	<p>12525 1.291 kg/m</p> <p>40 45</p>
<p>12526 1.245 kg/m</p> <p>26,5 45</p>	<p>12527 1.444 kg/m</p> <p>26,5 53</p>		



OP40 OFİS BÖLME PROFİLLERİ

OP40 OFFICE PARTITION PROFILES

<p>8550 0.952 kg/m</p>	<p>8551 0.788 kg/m</p>	<p>8554 1.142 kg/m</p>	<p>8557 0.627 kg/m</p>
<p>8556 1.544 kg/m</p>	<p>8555 0.326 kg/m</p>	<p>8553 0.325 kg/m</p>	<p>8552 0.281 kg/m</p>
<p>8558 1.582 kg/m</p>	<p>8559 1.163 kg/m</p>	<p>5992 0.080 kg/m</p>	<p>1662 2.576 kg/m</p>
<p>2046 2.091 kg/m</p>	<p>1931 0.688 kg/m</p>	<p>8585 0.202 kg/m</p>	<p>8583 0.327 kg/m</p>
<p>8581 1.379 kg/m</p>	<p>8584 0.660 kg/m</p>	<p>8582 0.202 kg/m</p>	<p>12529 0.484 kg/m</p>
<p>4112 0.078 kg/m</p>			



OP100 OFİS BÖLME PROFİLLERİ

OP100 OFFICE PARTITION PROFILES

<p>7121 0.666 kg/m</p>	<p>7122 0.542 kg/m</p>	<p>7138 0.500 kg/m</p>	<p>7127 0.780 kg/m</p>
<p>7126 1.137 kg/m</p>	<p>7132 0.888 kg/m</p>	<p>7133 1.141 kg/m</p>	<p>7137 1.568 kg/m</p>
<p>7135 1.065 kg/m</p>	<p>7136 1.034 kg/m</p>	<p>7139 0.413 kg/m</p>	<p>7134 0.528 kg/m</p>
<p>7140 0.508 kg/m</p>	<p>7141 0.479 kg/m</p>	<p>7129 0.467 kg/m</p>	<p>7130 0.455 kg/m</p>
<p>7131 0.600 kg/m</p>	<p>7128 1.006 kg/m</p>	<p>7123 0.264 kg/m</p>	<p>7125 0.202 kg/m</p>
<p>1931 0.688 kg/m</p>	<p>8557 0.627 kg/m</p>	<p>7142 0.189 kg/m</p>	<p>5022 2.245 kg/m</p>
<p>1695 2.540 kg/m</p>	<p>7124 0.108 kg/m</p>	<p>5992 0.080 kg/m</p>	<p>8585 0.202 kg/m</p>



SÜPÜRGELİK ve EŞİK PROFİLLERİ

BASEBOARD AND THRESHOLD PROFILES

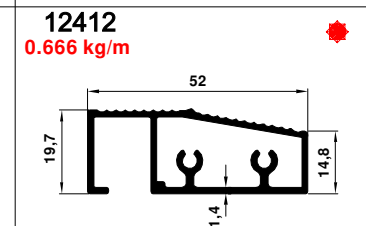
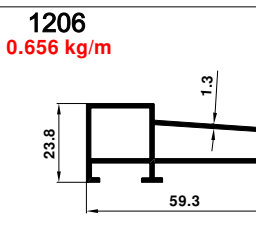
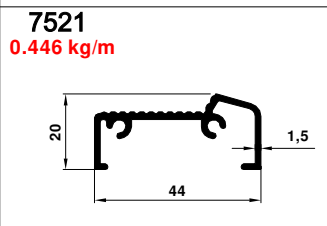
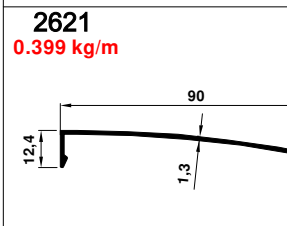
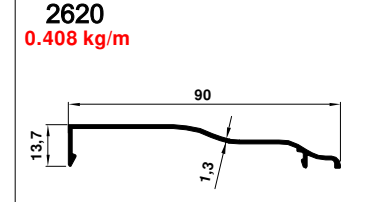
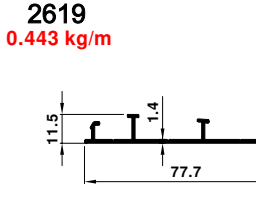
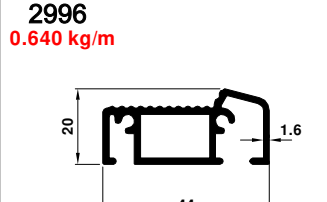
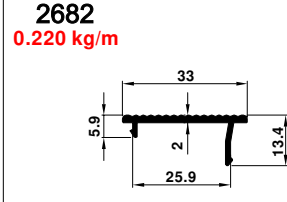
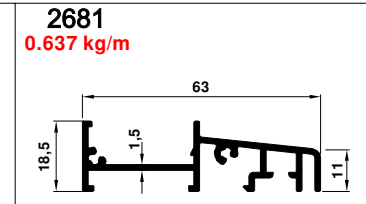
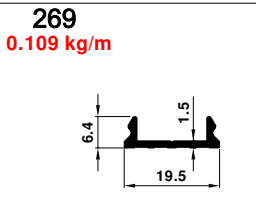
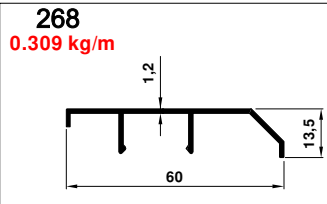
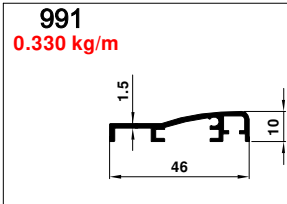



CB 40 CAM BALKON SERİSİ

CB40 BALCONY GLAZING SERIES

<p>3962 1.475 kg/m</p>	<p>10283 1.339 kg/m</p>	<p>11721 1.468 kg/m</p>	<p>10282 0.887 kg/m</p>
<p>3990 0.991 kg/m</p>	<p>3961 0.993 kg/m</p>	<p>11490 0.942 kg/m</p>	<p>7617 0.538 kg/m</p>
<p>3045 0.515 kg/m</p>	<p>7326 0.169 kg/m</p>	<p>7327 0.142 kg/m</p>	<p>7618 1.248 kg/m</p>
<p>8249 0.554 kg/m</p>			



ICB40 ISICAMLI CAM BALKON SERİSİ

ICB40 HEAT INSULATED FOLDING BALCONY GLAZING SERIES

<p>11551 1.371 kg/m</p>	<p>12701 1.414 kg/m</p>	<p>11553 0.412 kg/m</p>	<p>11552 0.724 kg/m</p>
<p>11554 0.786 kg/m</p>	<p>11555 0.714 kg/m</p>	<p>11799 0.443 kg/m</p>	<p>11800 0.618 kg/m</p>
<p>1022 0.073 kg/m</p>			



SCB100 SÜRME CAM BALKON SERİSİ

SCB100 SLIDING BALCONY GLAZING SERIES

<p>5430 1.533 kg/m</p>	<p>5425 1.737 kg/m</p>	<p>9678 0.759 kg/m</p>	<p>6198 0.143 kg/m</p>
<p>12014 1.032 kg/m</p>	<p>12015 0.715 kg/m</p>	<p>12016 0.352 kg/m</p>	<p>5429 0.156 kg/m</p>
<p>12018 1.165 kg/m</p>	<p>12017 1.189 kg/m</p>	<p>6196 0.143 kg/m</p>	<p>6199 0.134 kg/m</p>
<p>7191 0.106 kg/m</p>	<p>7187 0.098 kg/m</p>	<p>7326 0.169 kg/m</p>	<p>9676 0.640 kg/m</p>



ISCB140 ISICAMLI SÜRME CAM BALKON SERİSİ

ISCB140 SLIDING HEAT INSULATED BALCONY GLAZING SERIES

<p>12664 1.915 kg/m</p>	<p>12665 1.192 kg/m</p>	<p>13164 1.364 kg/m</p>	<p>13163 0.865 kg/m</p>
<p>13166 2.540 kg/m</p>	<p>13165 1.588 kg/m</p>	<p>12669 0.632 kg/m</p>	<p>12666 0.861 kg/m</p>
<p>13162 0.180 kg/m</p>	<p>12670 0.583 kg/m</p>	<p>12667 0.550 kg/m</p>	<p>12671 0.361 kg/m</p>
<p>12672 0.599 kg/m</p>	<p>12668 0.965 kg/m</p>	<p>4104 0.391 kg/m</p>	



WG70 THERMO KIŞ BAHÇESİ SERİSİ

WG70 THERMO WINTER GARDEN SERIES

<p>30-9950-9951 1.870 kg/m</p> <p>72,9 69,4 9950 9951 34 64,5</p>	<p>34-9950-9951 1.894 kg/m</p> <p>76,9 69,4 9950 9951 34 64,5</p>	<p>30-9952-9953 3.116 kg/m</p> <p>161,6 56 9952 9953 63,3</p>	<p>34-9952-9953 3.140 kg/m</p> <p>165,6 56 9952 9953 63,3</p>
<p>34-9955-9956 3.154 kg/m</p> <p>82 142 9956 9955 29</p>	<p>34-9957-9958 5.355 kg/m</p> <p>124 178 9957 9958</p>	<p>34-9962-9963 5.883 kg/m</p> <p>123 123 9962 9963</p>	<p>34-9964-9965 3.391 kg/m</p> <p>118 80 9964 9965</p>
<p>34-9966-9967 2.936 kg/m</p> <p>62,5 142 9966 9967 36</p>	<p>34-9985-9984 2.522 kg/m</p> <p>50 118 9985 9984 55</p>	<p>55-1704-1769 1.510 kg/m</p> <p>42 55 1704 1769 64</p>	<p>64-1704-1769 1.580 kg/m</p> <p>42 64 1704 1769</p>
<p>34-9979-9980 4.990 kg/m</p> <p>113 142 9979 9980</p>	<p>9982 0.461 kg/m</p> <p>85,4 13,1</p>	<p>9970 0.680 kg/m</p> <p>40,9 85,5</p>	<p>9971 0.324 kg/m</p> <p>169,9 49,2</p>
<p>9981 1.548 kg/m</p> <p>57,4 90 2</p>	<p>9972 2.064 kg/m</p> <p>106 95</p>	<p>9978 0.111 kg/m</p> <p>17,4 4,9</p>	<p>9973 0.349 kg/m</p> <p>41,4 35,6</p>
<p>9961 0.324 kg/m</p> <p>32 21,8</p>	<p>9968 1.354 kg/m</p> <p>157 36,9</p>	<p>9977 2.368 kg/m</p> <p>120 88,8</p>	<p>9975 0.242 kg/m</p> <p>19,3 9,2</p>
<p>9969 0.197 kg/m</p> <p>11,1 27</p>	<p>11885 0.663 kg/m</p> <p>22,5 34,8</p>	<p>9954 1.544 kg/m</p> <p>80 59,3</p>	<p>9959 0.737 kg/m</p> <p>22,3 60</p>
<p>9960 0.578 kg/m</p> <p>60 5,8</p>	<p>6262 1.169 kg/m</p> <p>120 46,8</p>	<p>6263 1.173 kg/m</p> <p>120 46,8</p>	<p>9974 3.439 kg/m</p> <p>59,5 65,2</p>



WG70 THERMO KIŞ BAHÇESİ SERİSİ

WG70 THERMO WINTER GARDEN SERIES



<p>1698 0.270 kg/m</p>	<p>3539 0.277 kg/m</p>	<p>1699 0.285 kg/m</p>	<p>1745 0.292 kg/m</p>
<p>1949 0.306 kg/m</p>	<p>2236 0.310 kg/m</p>	<p>1966 0.314 kg/m</p>	<p>3636 0.321 kg/m</p>
<p>3536 0.329 kg/m</p>	<p>1747 0.340 kg/m</p>	<p>1749 0.356 kg/m</p>	<p>3537 0.367 kg/m</p>
<p>5546 0.271 kg/m</p>	<p>5527 0.293 kg/m</p>	<p>1663 3.526 kg/m</p>	